

# OBC NORTHWEST, INC.

## Nursery & Greenhouse Supplies

Your Complete Source for  
Greenhouse, Nursery and B&B  
Supplies and Accessories since 1954



2014-2015  
SUPPLY  
CATALOG

**60**  
**YEARS**  
**1954 - 2014**

*A special thanks to  
our customers for their  
support over the years...  
we owe our success to you.*



*Everything you need to grow!*

Greenhouse Supplies • Bamboo • Burlap • Containers • Fertilizer • Hardware • Label Printers & Printing  
Poly Film • Ground Cover • Poly Pots • Shade Cloth • Soil • Twine • Tye Tapes • Wire Baskets

1076 SW Berg Parkway, Canby, Oregon 97013 • 800-477-4744 • 503-266-2021 • Fax 503-266-6837  
Check out our website at [www.obcnw.com](http://www.obcnw.com) • Email: [obc@obcnw.com](mailto:obc@obcnw.com)



23 mm EarthPots  
Pepper transplants in  
Imperial's Garden field



**"Hands down,  
EarthPots® are  
the best for  
field transplant."**

— Imperial's Garden  
Wapato, WA



23 mm EarthPots in Imperial's Garden greenhouse

**EARTHPOTS®**  
LIVE HEALTHY · PLANT HEALTHY

Manufactured by  
OBC Northwest Inc. Canby, OR

**Are you Growing in EarthPots?  
What are you waiting for?**

**Apples to Zinnia  
Azaleas to Zucchini**

**Everything that grows *roots*  
grows *better* in EarthPots**

**Increase Productivity  
Increase Profits with EarthPots**

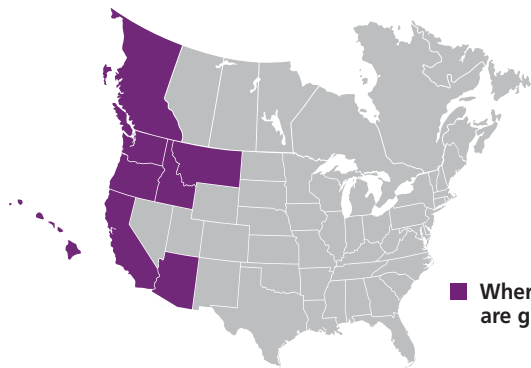

■ Where EarthPots®  
are growing



70 mm EarthPot



Zucchini getting a healthy start in 80 mm EarthPots

Delivery Schedule .....	3
Burlap & Twine .....	4
Wire Baskets .....	5-6
B & B Supplies/Accessories .....	7-8
Tapes & Ties .....	9-11
Grafting Supplies .....	12-13
Nursery Stakes .....	14
Pruning Supplies .....	15-19
Tools .....	20-22
Nursery Labels & Printers .....	23-27
Christmas Tree Supplies .....	28
Propagation Supplies .....	29
Watering Supplies .....	30-33
Nursery Carts & Trailers .....	34
Fertilizers .....	35
Soil Mixes .....	36-37
Fertilizer Applicators .....	38
Fertilizer Injectors .....	39
Chemical Accessories .....	40-41
Gloves & Protective Clothing .....	42
Greenhouse Construction .....	43
OBC Greenhouses .....	44-45
Conley's Greenhouses, Benches & Doors .....	46-47
Greenhouse Controls .....	48
Greenhouse Heating Systems .....	49
Greenhouse Accessories .....	50-55
Greenhouse Coverings .....	56
Crop Covers and Ground Covers .....	57-58
Shade/Insect Fabrics .....	59
EARTHPOTS.....	60-61
Containers .....	62-74
Conversion Tables .....	75
Terms .....	76
Index .....	77-78
Credit Application .....	79

**CALL TOLL FREE 1-800-477-4744**

(503) 266-2021 | Fax: (503) 266-6837



Email: [obc@obcnw.com](mailto:obc@obcnw.com)  
[www.obcnw.com](http://www.obcnw.com)

**STORE HOURS**

Monday – Friday 7:30 am to 5:00 pm

**Mailing Address:**

P.O. Box 759  
 Canby, OR 97013

**Physical Address:**

1076 SW Berg Parkway  
 Canby, OR 97013

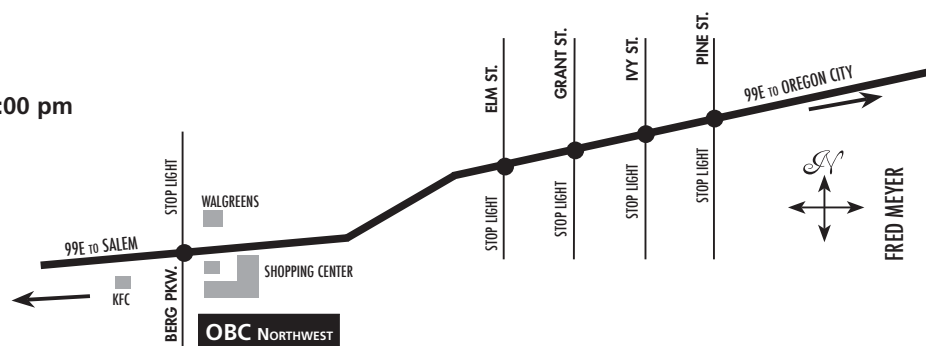





# OBC NORTHWEST INC.

ESTABLISHED 1954

In 1954, in an aging old pickle plant in Aurora, Oregon Bag Company had its beginning. With founder Charles (Charlie) Boyce, and a small core of determined employees, a burlap bag company was born to service the entire Willamette Valley and Southern Washington.

As time passed, the company grew and the product lines changed to include paper bags, leno mesh bags, cotton bags and even sleeping bags. In 1962 the company was expanded and moved to Canby; a larger facility and more employees were needed to accommodate the ever-increasing business.

The company continued to grow, mostly by adding new lines to promote the nursery industry. During the eighties, OBC saw its bag business dying, due to strong demand for imported bags shipped into the US and sold for less than locally produced bags.

The decision was made by OBC to expand into the horticultural market and let the bag business continue as long as it could remain profitable. Greenhouse manufacturing was added to the product mix, opening the door to a new segment of the nursery industry.

New buildings were constructed to accommodate the growth, along with customer service support and sales staff. A name change was introduced to move away from the idea of a bag business, but was designed to keep in mind the company's successful history: OBC Northwest, Inc. was adopted in 1989.

Today, OBC Northwest, Inc. operates within four acres of manufacturing and warehouse facilities to service both the agricultural and the horticultural industry.

It is with great pride that we still represent the spirit of our original employees: In order to succeed, we as employees must have a commitment for turning in the best possible performance on every job... in every department... for every customer... every day.







**Bob Buck**  
Oregon Sales



**Jay Gilbertson**  
Washington Sales



**Gary Kessel**  
Oregon Sales



**Don Knievel**  
Territory Sales



**Jay Cushman**  
Greenhouse Sales



**Melanie Miller**  
EARTHPOTS Sales



**Jim Hayes**  
EARTHPOTS Sales



**Trevor Boyce**  
Greenhouse & Production Manager



**Randy Epperly**  
Construction Manager



**Sheila Sasse**  
Inside Sales & Marketing Manager



**Maria Finster**  
Purchasing Agent



**Jeanette Ruiz**  
Customer Service



**Jen Scheler**  
Customer Service



**Nancy Savelieff**  
Customer Service



**Natasha Reutov**  
Customer Service



**Caryl Miller**  
Accounting Manager



**Brianna Berreth**  
Accounts Receivable



**Tina Stringfield**  
Accounts Receivable



**Dave Bell**  
Warehouse Manager



Warehouse: (left to right) Rich Morales, Matt Charaba and Abe Morales.



The drivers at OBC, (left to right) Russ Trudeau, Dan Stoller and Grant Myers.

## Delivery Charges

The fuel charge will vary depending on location; with an order of \$350 or more, we will deliver your order as follows: a fuel charge of \$20 on our local delivery route, \$50 will be applied for long distance deliveries, and \$60 for deliveries to Canada. For orders under \$350, a fuel charge of \$65 will be added. Orders need to be placed no later than 3:00 pm the day before delivery for stocked items. Canadian orders need to be placed by noon the Thursday before delivery.

Deliveries outside our regularly scheduled delivery area can be arranged by motor freight or common carrier.

## Regular Delivery Schedule

### MONDAYS

**SOUTHWEST:** Amity, Carlton, Dallas, Dayton, Dundee, Independence, Keizer, Lafayette, Lake Oswego, McMinnville, Monmouth, Newberg, Rickreall, St. Paul, West Salem, Sheridan, Sherwood, Tualatin, West Linn, Willamina, Wilsonville, Yamhill.

**NORTH:** Washington I-5 Corridor (north of Ridgefield) to Vancouver B.C. (Two Day Run)

### TUESDAYS

**EAST:** Boring, Colton, Eagle Creek, Estacada, Gladstone, Gresham, Milwaukie, Molalla, Oregon City, East Portland, Sandy.

### WEDNESDAYS

**SOUTH:** Albany, Alvadore, Aumsville, Aurora, Brooks, Brownsville, Corvallis, Creswell, Eugene, Gervais, Halsey, Harrisburg, Jefferson, Junction City, Lebanon, Lowell, Monroe, Mount Angel, Philomath, Pleasant Hill, East Salem, Scio, Shedd, Silverton, Stayton, Sublimity, Sweet Home, Tangent, Turner, Woodburn.

### THURSDAYS

**EAST:** Battleground WA, Boring, Brush Prairie WA, Gresham, Oregon City, East Portland, Ridgefield WA, Sandy, Vancouver WA, Woodland WA.

**WEST:** Aloha, Banks, Beaverton, Cornelius, Forest Grove, Gaston, Hillsboro, Kansas City, North Plains, NW Portland, Tigard, St. Helens, West Linn, Wilsonville.

### FRIDAYS

Same as Wednesday's delivery schedule.

### FAR SOUTH RUN

Truck leaves for a two day run every two weeks, orders permitting. Route: Cottage Grove I-5 to the Oregon-California border.

*If you are not covered by our delivery schedule or would like additional information, please call 1-800-477-4744 and we can discuss other possibilities.*





## Bulk Burlap

Our bulk burlap is available both treated and untreated. Treated burlap is sold in 500 yard rolls. Untreated burlap is sold in bolts of approximately 100 yards (sizes may vary from 60 to 130 yards). Plain burlap can also be put up in 500 yard rolls.

Our burlap is treated with the only EPA approved copper formula, which is monitored on a daily basis to ensure the correct percentages.

**Available in 7 oz. or heavy weight**  
**Widths Available: 30"; 32"; 36"; 40"; 45"; 48"; 54"; 60" and 72"**

## Burlap Basket Liners

OBC Northwest manufactures basket liners to fit into wire baskets at our factory in Canby, Oregon. We have the capability to manufacture treated and plain liners. If you require a special design, we can engineer and fabricate almost anything.

**Available in 7 oz. or heavy weight**

## Burlap Nursery Squares

Don't be fooled by inferior, low-cost squares that will not last the season. OBC Northwest offers the best quality, long-lasting, EPA approved burlap squares on the market today. Squares are available both treated and untreated.

**Note:** Due to varying conditions, longevity of treated burlap cannot be guaranteed.

**7 oz. stock; Heavy stock available upon request.**

**\*See page 76 for burlap definition.**

Prod. Code (Treated)	Prod. Code (Untreated)	Square Size	Quantity/Bundle	Weight/Bundle	Avg. Ball Diameter
NST24	NSP24	24x24"	100	18	6" - 8"
NST28	NSP28	28x28"	100	27	8"-10"
NST30	NSP30	30x30"	100	27	10"-12"
NST32	NSP32	32x32"	100	40	12"-14"
NST36	NSP36	36x36"	100	44	14"-16"
NST40	NSP40	40x40"	100	48	18"-20"
NST45	NSP45	45x45"	50	32	20"-22"
NST48	NSP48	48x48"	50	47	22"-24"
NST54	NSP54	54x54"	50	50	24"-26"
NST60	NSP60	60x60"	50	61	26"-28"
NST72	NSP72	72x72"	25	45	30"-34"
NST80	NSP80	80x80"	10	23	36"-40"
NST96	NSP96	96x96"	10	38	42"-48"



## Sisal & Poly Twine

Prod. Code	Twine Type	Yield/Bale	Weight	Put-Up	Approx. Knot Strength
TS1PT	1-ply Sisal, Treated Copper	15,000 ft.	50 lb.	10-5# balls	110 lb.
TS2PT	2-ply Sisal, Treated Copper	7,500 ft.	50 lb.	10-5# balls	170 lb.
TS3PT	3-ply Sisal, Treated Copper		50 lb.	10-5# balls	
TS1PP	1-ply Sisal, Plain, Unoleid	15,000 ft.	50 lb.	10-5# balls	105 lb.
TS2PP	2-ply Sisal, Plain, Unoleid	7,500 ft.	50 lb.	10-5# balls	160 lb.
TS9000	9,000 Sisal Baler, Oiled	8,600 ft.	40 lb.	2-20# balls	135 lb.
TS7200	7,200 Sisal Baler, Oiled	6,800 ft.	40 lb.	2-20# balls	160 lb.
TS550B	550 Sisal Binder Twine, Oiled	27,500 ft.	50 lb.	10-5# balls	55 lb.
TS1PTXHD	1-ply Treated/X-Heavy Duty	9,250 ft.	50 lb.	10-5# balls	
TP9000	9,000 Poly Baler, Orange	9,000 ft.	20 lb.	2-9# balls	130 lb.
TP7200	7,200 Poly Baler, Orange	7,200 ft.	20 lb.	2-9# balls	180 lb.
TP7200Y	7,200 Poly Baler, Yellow	7,200 ft.	20 lb.	2-9# balls	
TP5000	5,000 Poly Baler, Orange	5,000 ft.	16 lb.	1-16# ball	210 lb.
TSF850	850 Poly Split Film, White	850 ft./lb.	10 lb.	10# ball	85 lb.
TSF650	650 Poly Split Film, White	650 ft./lb.	10 lb.	10# ball	125 lb.
TSF550	550 Poly Split Film, White	550 ft./lb.	10 lb.	10# ball	140 lb.
TPTL	950 Tree Lock Rope, Black	190 ft./lb.	40 lb.	8-5# balls	640# tensile
TSX	1/2" Strapex	15,600 ft.	60 lb.	4-15# coils	675# tensile
TSX34	3/4" Strapex	8,400 ft.	50 lb.	4-12# coils	1035# tensile
TPXTT	Xmas Tree Tying twine	65,200 ft.	40 lb.	8-5# balls	90# tensile
TPXTTR	Xmas Tree Tying twine, Red	65,200 ft.	40 lb.	8-5# balls	90# tensile



Call or go online for large quantity orders, additional info and current prices.



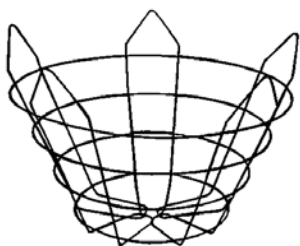

## Vermeer Short 25° Baskets

Prod. Code	Size (Top x Bottom x Height)	No. of Rings	No. of Verticals	Gauge	Liner Size	Weight
WBVSCB24	24" x 15" x 11"	3	5	10	36" x 40"	1.49
WBVSCB28	28" x 16" x 13.5"	3	5	9	40" x 45"	1.66
WBVSCB32	32" x 20" x 15"	3	5	9	48" x 48"	2.65
WBVSCB36	36" x 20" x 18"	4	5	8	54" x 54"	3.49
WBVSCB40	40" x 24" x 18"	4	5	8	60" x 60"	4.21
WBVSCB44	44" x 25" x 22"	4	6	8	72" x 72"	4.54

## Vermeer Deep 25° Baskets

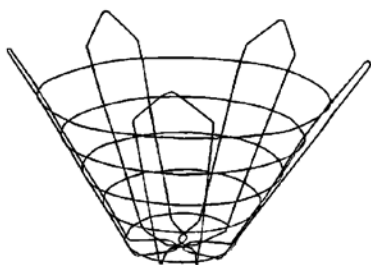

Prod. Code	Size (Top x Bottom x Height)	No. of Rings	No. of Verticals	Gauge	Liner Size	Weight
WBVDCB20	20" x 12" x 11"	3	4	12	30" x 36"	1.40
WBVDCB24	24" x 12" x 13.5"	3	4	10	36" x 40"	1.49
WBVDCB28	28" x 12" x 18"	4	5	10	45" x 45"	2.45
WBVDCB32	32" x 16" x 20"	5	5	9	48" x 50"	2.87
WBVDCB36	36" x 16" x 24"	5	5	8	54" x 60"	3.55
WBVDCB40	40" x 20" x 24"	5	5	8	60" x 60"	4.61
WBVDCB44	44" x 20" x 27.5"	5	5	8	72" x 72"	5.34
WBVDBF50	50" x 23" x 30"	5	6	6	72" x 80"	6.25
WBVDBF54	54" x 27" x 32"	5	7	7	72" x 80"	7.49
WBVDBF60	60" x 29.5" x 35"	6	8	7	85" x 96"	9.24

## Truncated 22° Baskets

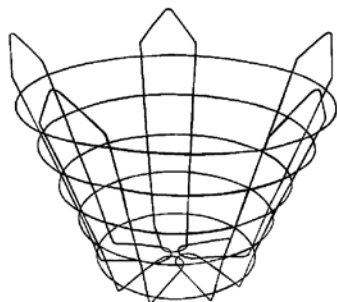

Prod. Code	Size (Top x Bottom x Height)	No. of Rings	No. of Verticals	Gauge	Liner Size	Weight
WBTCB16	16" x 8" x 8"	3	3	12	30" x 30"	.56
WBTCB18	18" x 10.5" x 10"	3	4	12	30" x 36"	.75
WBTCB20	20" x 12" x 11"	3	4	12	30" x 36"	1.15
WBTCB24	24" x 14" x 13.5"	3	5	10	40" x 40"	1.58
WBTCB26	26" x 14" x 15"	4	5	10	45" x 45"	2.25
WBTCB28	28" x 15" x 18"	4	5	10	45" x 45"	2.38
WBTCB32	32" x 18" x 20.25"	5	5	9	48" x 50"	3.04
WBTCB36	36" x 21" x 24"	5	5	8	54" x 60"	3.21
WBTCB40	40" x 24" x 24"	5	5	8	60" x 60"	5.4

## Cone-Style 30° Baskets



Prod. Code	Size (Top x Bottom x Height)	No. of Rings	No. of Verticals	Gauge	Liner Size	Weight
WBCCB24	24" x 10" x 13.5"	3	4	10	36" x 40"	1.49
WBCCB28	28" x 11" x 18"	4	5	9	45" x 45"	2.46
WBCCB32	32" x 13" x 20"	4	5	9	54" x 50"	2.76
WBCCB36	36" x 14" x 24"	5	5	9	54" x 60"	3.43
WBCCB40	40" x 16" x 24"	5	8	8	60" x 60"	3.50





# Cherokee Manufacturing Wire Baskets

## Flat Baskets

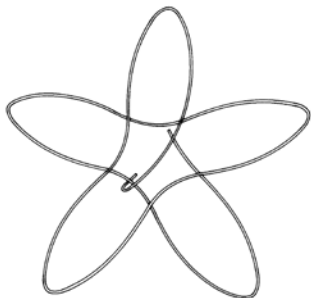

Prod. Code	Size	Ball Diam.	Burlap Sq.	Qty/Per Bdl	Weight Per Bdl.
WBFB26	26"	8-10"	28x28"	25	9.0
WBFB30	30"	10-12"	30x30"	25	11.25
WBFB36	36"	14-18"	36x36"	25	18.75
WBFB42	42"	20-24"	48x48"	25	20.0
WBFB48	48"	24-28"	60x60"	25	21.5
WBFB54	54"	30-36"	72x72"	25	23.25
WBFB80	80"	45-53"	108x108"	10	30.0
WBFB100	100"	55-60"	120x120"	5	43.0

## Optimal Wire Baskets

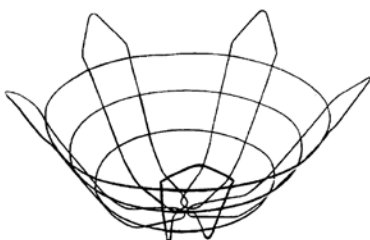

Prod. Code	Size (Top x Bottom x Height)	No. of Rings	No. of Verticals	Weight
WBOCB24	24" x 16" x 10"	3	4	1.44
WBOCB28	28" x 19" x 10"	3	5	1.66
WBOCB32	32" x 20" x 12"	3	5	2.65
WBOCB36	36" x 17.5" x 17.5"	4	5	3.19
WBOCB40	40" x 21.5" x 17.5"	4	5	4.00
WBOCB45	45" x 21.5" x 22"	5	6	5.42
WBOCB48	48" x 24" x 22"	5	6	6.17
WBOCB54	54" x 26" x 25"	6	6	7.54
WBOCB60	60" x 28" x 27.5"	6	8	11.08

## Other Wire Baskets



## Large Vermeer Wire Baskets with Lifting Lugs\*

Prod. Code	Size (Top x Bottom x Height)	Lifting Lugs	Weight
WBBJ72	72" x 30-3/8" x 44-3/16"	3	38 lb.
WBBJ87	87" x 39-1/2" x 42"	4	50 lb.

\* other sizes available



## B & B Cart

Lift the ball right from the hole. Made of heavy 1 inch tube frame, with 15x6.00-6 tires. 1,100 lb. capacity.

Prod. Code	Weight
HKCKB30	80 lb.
HKCKB36	100 lb.

## Wire Basket Crimper



For crimping your wire baskets snug to the root ball. Made of 1-inch round tubing.

Prod. Code	Size	Wt. Lb.
WBC36	12"x3'	2.75
WBC12	12"x12"	2
WBC12P	12"x12" pigtail	2

## Container Cart

Can carry a 25 gallon pot. 1,100 lb. capacity.

Prod. Code	Weight
HKCKBG25	105 lb.

## Stretch Wrap

Sold by the roll. Four rolls per case.

Prod. Code	Size	Weight
MSSW1580	15" x 80 GA.	9 lb.



## Barnel BB / Pack-It Tree Tote

Select wide to hold odd shapes securely or tapered to fit easily under root balls and nursery containers.

Prod. Code	Description	No. Bars	Weight
MSP7T	Tapered	7	3 lb.
MSP7W	Wide	7	3 lb.
MSP34C	3-4 combo	8	6.5 lb.

## Amaroo Tree Boxes



- 4-way fork-liftable base.
- Root directors prevent root circling.
- Reusable container is easily assembled and disassembled.
- Air vents for ample drainage and root pruning.
- Customized options available, including: drainage vents, multiple colors and customer name/phone number.

For specifications, see page 72



## Nylon Sling

For lifting heavy baskets, trees, shrubs, etc. Custom sizes are available.

Prod. Code	Size	Vertical Hold	Basket Hold	Choke Hold	Weight
MSS34	3" x 4'	5,400 lb.	10,800 lb.	4,000 lb.	2 lb.
MSS44	4" x 4'	7,200 lb.	14,400 lb.	5,400 lb.	2.5 lb.
MSS45	4" x 5'	7,200 lb.	14,400 lb.	5,400 lb.	3 lb.
MSS46	4" x 6'	7,200 lb.	14,400 lb.	5,400 lb.	3.5 lb.

## Carrier Mill Bastard File



Prod. Code	Description	Size	Weight
HMF10B	Bastard Smooth Cut File	1" x 10"	.5 lb.
HMF14B	Bastard File	1-1/4" x 14"	1.25 lb.



## Hog Ring Stapler

Self-feeding, wraps staples around twisted neck of burlap. Faster and easier than sewing on burlap balls.



Prod. Code.	Description	Wt. Lbs.
HMSTAP7	P-7 Hog Ring Stapler	1
HMSTA	Hog Ring Staples 2500 Staples/box	2.75

## Pneumatic Stapler

Prod. Code.	Description	Quantity
HMSTASC743	Pneumatic Stapler	1
HMSTA16GA110	Pneumatic Staples	11,000/cs

## Pinning Nails

Oval head pinning nails used for pinning burlap in place on B&B root balls. Packaged in 50 lb. boxes.



Prod. Code	Size	Length
HMPN	6-D	2.25"

Approximately 14,250 nails per 50 pound box.



HMCC



HMCP



HMCD

## Calipers

### Chase Tree Gauge (Product Code: HMCC)

Scales in inches and mm for caliperling seedlings 2/16" to 3/4".

### Plastic Pocket (Product Code: HMCP)

Large 6.5" diameter capacity on 1/4" scale.

### Drescher Tree (Product Code: HMCD)

Aluminum alloy. Accurate measurements from 1" to 8" on one side; 1 - 20 cm on the other. 9-1/2" overall size.

Prod. Code	Description	Weight/oz.
HMCC	Chase Tree Gauge	1
HMCP	Plastic Pocket	1
HMCD	Drescher Tree	4

## Rubber Bands



For use on rhododendrons etc. Wrap branches tight to tree or bush to prevent whipping and broken branches during shipping. Sold by the pound. 5 lb. bags, 25 lb./cs.

**For large quantities, order in October for February/March delivery. Call for prices.**

Prod. Code.	Size	Quantity Per Lb.
TRB107	3/4 x 7"	45

## Paper Tree Wrap

Protects against sun-scald, loss of moisture and insect attacks. 10 rolls/case. Sold by the roll.



Prod. Code	Roll Size	Wt. Lbs.
MSTPTW4150	4" x 150'	2

## Plastic Tree Trunk Protectors

Can be applied in the fall and over-wintered without breaking down like corrugated paper products. The white outside will help reflect sunlight and protect the trunk from sun-scald. The protector will also act as a cushion when the tree is shipped and help prevent trunk damage. Sold by bundles or pallets.



Prod. Code	Size	Wt. Lbs.-50/bundle	Wt. Lbs.
MSTPPTG	12" x 32"	17	550 (1520/pallet)
MSTPPTG1248	12" x 48"	30	320 (600/pallet)

## Twine Knives

The ring is aluminum, rivets are nickel-plated brass and the blade is a heat-treated 1095 high carbon steel. Wear on a finger of either hand. Sizes 8 thru 15. 12/box. Sold individually.



Prod. Code	Size	Wt. Lbs./Dz.
HRK06	6	.25
HRK07	7	.25
HRK08	8	.25
HRK09	9	.25
HRK10	10	.25
HRK11	11	.25
HRK12	12	.25
HRK13	13	.25
HRK14	14	.25
HRK15	15	.25

Call or go online for large quantity orders, additional info and current prices.



## Stretch Tie

35% faster than hand tying. No machines to lose, break, jam or buy. Tighter than machines and less reworking. Developed by nursery professionals. Available in 6" and 10" lengths. Sold by the box, 4000 per box.

Prod. Code	Description	Weight
FTST	6" Stretch Tie	8 lb.
FTST10	10" Stretch Tie	14 lb.



## Chain Lock

Heavy gauge plastic, adjustable lock. For supporting trees and plants when staking is required. Supplied on 100' reels.

Prod. Code	Size Tie/Description	Wt. Lbs.
FTIA3100	1/2" x 100'	3
FTIA5100	1" x 100'	5

## Plant Ties

Eight inch hard and soft ties. Easy to apply in cold or warm weather. Packaged in bundles of 1000. Prices per 1000. Weight: 1 lb./per 1000; 30,000 per case.

Prod. Code	Size Tie/Desc.
FTIPTH	8" hard tie
FTIPTS	8" soft tie

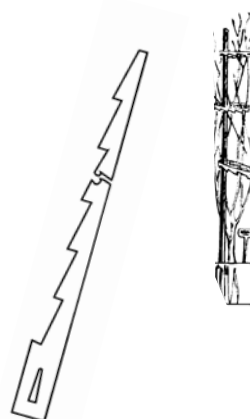

## Insta-Ties

Available in red or green. Wire reinforced paper ties. Inexpensive and easy to use. Other sizes available. For information, call 1-800-477-4744

Prod. Code (Red or Green)	Length	Qty./Bndl	Qty./Case
FTINB04RBN or FTINB04GBN	4"	250	25,000
FTINB05RBN or FTINB05GBN	5"	250	25,000
FTINB06RBN or FTINB06GBN	6"	250	25,000
FTINB07RBN or FTINB07GBN	7"	250	25,000
FTINB08RBN or FTINB08GBN	8"	250	25,000
FTINB10RBN or FTINB10GBN	10"	250	25,000
FTINB12RBN or FTINB12GBN	12"	250	10,000
FTINB14RBN or FTINB14GBN	14"	250	10,000
FTINB18R	18"	125	10,000

Note: 4"-8" There are 100 bundles per case. 10"-14" There are 40 bundles per case.



## Ty'm Up Tape

Vinyl tape used for training and staking plants. Strong, stretchy, long lasting. The Miracle Garden Tie and Standard Tye can be used in the Max Tapeners. Priced per roll.



### Miracle Garden Tie 1/2" Tape (Fits HTB tapener)

Prod. Code.	Size	Rolls/Pack	Rolls/Case	Wt./Pk.
FTM3440	1/2"x 120'x 4 mil green	24	288	3.75 lb.
FTM3441	1/2"x 80'x 6 mil green	24	288	3.75 lb.
FTM3442	1/2"x 60'x 8 mil green	24	288	3.75 lb.

### Standard Tye 1/2" Tape (Fits HTB-2 tapener)

Prod. Code.	Size	Roll/Pack	Rolls/Case	Wt./Pk.
FTM3400	#3400 1/2"x 300'x 4 mil green tape	24	144	
FTM1256E	12-5-6E 1/2"x 200'x 6 mil green tape (machine)	24	96	6 lb.
FTM1258E	12-5-8E 1/2"x 150'x 8 mil green tape (machine)	24	96	6 lb.
FTM1258EW	12-5-8EW 1/2"x 150'x 8 mil white tape (machine)	24	96	6 lb.

### Jumbo Tye 1" Tape (For Hand Tying)

Prod. Code.	Size	Rolls/Pack	Rolls/Case	Wt./Pk.
FTM1216	12-1-6 1"x 200' 6 mil green	12	48	7.5 lb.
FTM1218	12-1-8 1"x 150' 8 mil green	12	48	7.5 lb.
FTM3421	#3421 1"x 150' 8 mil green	12	72	7.5 lb.
FTM12112	12-1-12 1"x 100' 12 mil green	12	48	7.5 lb.
FTM3422	#3422 1"x 100' 12 mil green	12	72	7.5 lb.

## Max Tapes

Max 1/2" tapes - Use with HTB tapeners. Sold by the box. 10 rolls per box. 300 rolls/case

Prod. Code.	Size	Rolls/Pack	Rolls/Case	Wt./Pk.
FTMAX10	1/2"x 134'x 4 mil white	10	300	1.2 lb.
FTMAX15	1/2"x 87'x 6 mil blue	10	300	1.2 lb.
FTMAX25	1/2"x 54'x 10 mil red	10	300	1.2 lb.

## Chip Budding Tape

Prod. Code	Size	Rolls/Pack	Rolls/Case	Wt. Lbs.
FTTCBT12	1/2"x 800'x 2 mil	24	144	6
FTTCBT01	1"x 800'x 2 mil	12	72	6

## Parafilm Grafting Tape

Prod. Code	Size	Rolls/Pack	Rolls/Case
FTPF1	1"x 90'x 2 mil	6	72

Call or go online for large quantity orders, additional info and current prices.

# Flagging Tape



SOLID	STRIPE	POLKA DOT	CHECKERBOARD
Black	Blue/White	Blue/White	Blue/White
Blue	Orange/White	Orange/White	Orange/White
Orange	Red/White	Red/White	Pink Glo/White
Red	Yellow/White	Yellow/White	Red/White
Yellow	Green/White	Green/White	Yellow/White
Green	Black/White	Black/White	White/Black
White	Blue/Black	Blue/Black	Blue/Black
Purple	Orange/Black	Yellow/Black	Green/Black
Pink	Yellow/Black	Red/Black	Red/Black
Blue Glo	Red/Black	Red/Yellow	Yellow/Black
Lime Glo	Red/Yellow	Pink Glo/Black	Pink Glo/ Black
Orange Glo	Pink Glo/Black	Orange Glo/Black	
Red Glo	Orange Glo/ Black		
Pink Glo			
Yellow Glo			

**Please Note:** To order use Prod. Code: FTA(Pattern)(Color)  
 Pattern = Solid-S, Stripe-ST, Polka Dot-PD, Checkerboard-CB  
 Color-Use First Letter of each color. Blue/White = BW  
 Black=BL Glo=G

**Example: FFASTBW = FTA(Stripe)(Blue/White)**

Available in 1-3/16" width, this multi-purpose tape has long-lasting qualities when exposed to extreme conditions. Many colors and patterns available: solid, striped, glo, polka dot and checkerboard. Priced per roll, 12 rolls per box. Weight: 4 lbs./box.

## 1-3/16" Width Tape

Color/Description	Length
Solid	300'
Glo	150'
Stripe	300'
Polka Dot	300'
Checks	300'

## 1/2" Width Tape

1/2" Tape Available in **SOLIDS** Only: 24 Rolls/Tube White (**W**), Yellow (**Y**), Red(**R**), Blue (**B**), Orange Glo (**OR**), Pink Glo (**PG**)

**Please Note:** To order use Prod. Code: FT12(Color)

**Example: FT12W**

Color/Description	Length
Solid	300'

# Flag Stakes

Colored Wire Flag Stakes, available in White, Yellow, Red, Blue, Green, Orange, Orange Glo and Pink Glo. Sold in bundles of 100.

Colored Fiberglass Flag Stakes; Blue, Green, Orange, and Pink Glo. Sold in bundles of 50.

Flag Size: 4" x 5", 18" Length

Flag Size: 4" x 5", Total Length: 30"

Product Code: FTFS_		Product Code: FTFSF_	
Colors	Weight/Bundle	Colors	Weight/Bundle
Standard	3	Fiberglass	3
Glo	3	Staff	3

# Bird Scare Tape

1" x 500' Silver. Metalized Polyester. Warning: This tape conducts electricity. Do not place near or around electrical wiring or utility lines.



Prod. Code
FTTBST

# Max Tapeners, Blades, Staples

**HTB Tapener**  
 Product Code: FTMAXHTB

Use with the smaller MAX or Miracle Garden Tie. Opens to 2"



Wt. Lbs.
1.5

**HTB-2 Tapener**  
 Product Code: FTMAXHTB2

Holds larger rolls of MAX or Standard Tye Tape

Wt. Lbs.
1.75

**ACE Tapener**  
 Product Code: FTTB-SACE

Eliminates tape remnants after stapling. Also features a built in lock to keep tapener closed. Uses same tapes as HTB-2.



# Tapener Blades

Sold by the pack. 3 blades per package, 30 packs per sheet.

Prod. Code.	Description
FTMAXB	Max Brand Blades
PTHTBLADE	Other Blades

**Max Staples**  
 Product Code: FTMAXS

Sold by the box. 4800 staples per box. 10 boxes per carton. 200 boxes per case. Wt: 2 ozs./box





HT683



HT685



HT605



HT606



HT641



HT642



HV19050



HPGK & HPKS

## Grafting & Budding Knives

Product Code	Description	Weight
HT683	Tina budding knife, 1-3/4" stationary blade, 6-1/4" overall length.	2 oz.
HT685	Tina grafting knife, 2-1/4" stationary blade, 6-1/2" overall length.	2 oz.
HT605	Tina grafting knife, 2-1/2" folding blade, 4" handle.	2 oz.
HT606	Tina grafting knife, 2-1/4" folding blade, 4" handle.	2 oz.
HT641	Tina curved blade w/barklifter. 2" folding blade, 1/2", serrated thumb supporter, 4" handle.	2 oz.
HT642	Tina special rose budding pattern. Curved 2" folding blade with barklifter, 4" handle.	2 oz.
HV19050	Victorinox grafting knife. 2-1/4" folding stainless steel blade, 3-1/2" handle.	2 oz.
HPGK	Jameson Grafting & Budding Knife. 1-1/2" surgical steel blade, 4-1/2" heavy rubber-coated handle.	2 oz.
HXSK-3	K-3 pouch for fixed knifeblade - leather.	2 oz.

## Doc Farwell's Tree Seal

### Grafting Seal\*

Thicker material is colored to reflect and absorb sunlight for maximum natural healing. Yellow compound is primarily used for grafting. It is also used for tree damage.

\* Cannot be shipped in very cold weather

\* Do not allow product to freeze

### Damage Seal & Heal

Green wound dressing. Colored to blend well with tree foliage. Preferred by orchardists and nurserymen.



Prod. Code	Size	Wt. Lb.
MSGSQ/MSGSHQ	Quart	3.0
MSGSG/MSGSHG	Gallon	10.5



## Tree Kote

Protects shrubs, bushes, vines and trees from decay, insects and fungi. Patch damaged areas of trees & shrubs or apply to freshly pruned areas. Use to propagate orchids.

Prod. Code	Size	Wt. Lb.
MSGTK08	1/2 pint	.5
MSGTK16	16 oz	1.0
MSGTK32	1 qt. tub	3.0
MSGTKG	1 gal. tub	8.9

## Budding Strips

Width: 3/16" 

Width: 1/4" 

Width: 3/8" 

Due to the Natural Material of Budding Strips, the Manufacturer does not express or imply longevity of the Budding Strip.

Prod. Code	Length	Width	Thickness	Strips Per Lb.
MSBS4316010	4"	3/16"	.010	2,880
MSBS414016	4"	1/4"	.016	1,650
MSBS5316010	5"	3/16"	.010	2,250
MSBS514010	5"	1/4"	.010	2,131
MSBS514016	5"	1/4"	.016	1,200
MSBS5316016	5"	3/16"	.016	1,700
MSBS5316020	5"	3/16"	.020	1,400
MSBS514020	5"	1/4"	.020	950
MSBS6316020	6"	3/16"	.020	1,080
MSBS614010	6"	1/4"	.010	1,776
MSBS614016	6"	1/4"	.016	1,110
MSBS614020	6"	1/4"	.020	888
MSBS638020	6"	3/8"	.020	490
MSBS814016	8"	1/4"	.016	832
MSBS838020	8"	3/8"	.020	450

## Honing Oil

Washita Mountain honing oil. Time tested and proven over many years of use.

Prod. Code	Wt. Oz.
HSO3OZ	3



## Sharpening Stones

### Corona Sharpening Tool

- 5" super carbide file
- Ideal for sharpening all blades
- Easily fits in pocket
- No slip grip for easy use



Prod. Code	Wt. Oz.
HCAC8300	1.8

### Soft Arkansas Stone

The most rapid cutting stone. It will produce the fastest edge on your knife. Comes with a leather pouch.



### Hard Arkansas Stone

Fine grade. Best used for polishing an already sharp blade. Comes with a leather pouch.

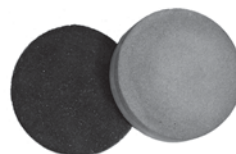

Oregon Stone



Bench Stone

### Oregon Stone

Round 3-inch sharpening stone, 5/8" thick.

Prod. Code	Size/Description	Wt. Oz.
HSSS	3 x 1 x 1/4" soft stone	3
HSLS	4 x 1-5/8 x 1/2" soft stone	6
HSSH	3 x 1 x 1/4" hard stone	3
HSLH	4 x 1-5/8 x 1/2" hard stone	6
HSRF	Fine Oregon Stone Rnd.	7
HSRM	Medium Oregon Stone Rnd.	7
HSRC	Coarse Oregon Stone Rnd.	7
HSB6	6" x 2" x 1" Bench stone	17.5
HSB8	8" x 2" x 1" Bench stone	23.6

Visit our comprehensive website, now including pricing and more products. Easy ordering for your convenience, 24 hours a day. Go to [www.obcnw.com](http://www.obcnw.com) and place your order now!

# Bamboo Cane Stakes

Top quality bamboo cane stakes from China are strong and uniform.

- 12" splits – 12' lengths.
- 1/4" through 1-1/2" diameters.
- Bundle quantities and weights may vary.



## Natural

Size Ft.	Diam. Inches	Diam. MM	Wt. Lbs./Bundle	Qty./Bundle
2	5/16	6-8	30	1,000
2.5	3/8	8-10	30	500
3	3/8	8-10	35	500
4	3/8	8-10	45	500
4	7/16	10-12	35	250
4	1/2	12-14	45	250
5	3/8	8-10	60	500
5	7/16	10-12	35	250
5	1/2	12-14	50	250
5	5/8	15-17	35	100
6	1/2	12-14	50	200

Size Ft.	Diam. Inches	Diam. MM	Wt. Lbs./Bundle	Qty./Bundle
6	5/8	15-17	40	100
6	3/4	18-20	55	100
7	1/2	12-14	30	100
7	5/8	15-17	45	100
7	3/4	18-20	65	100
8	7/8	22-24	45	50
8	1	24-26	55	50
9	1	24-26	55	50
10	1	24-26	35	25
12	1-1/4	28-30	45	25
12	1-3/8	30-35	50	25

## Green Dyed

*Dyed to blend in with plants; color is not a preservative.*

Size Ft.	Diam. Inches	Diam. MM	Wt. Lbs./Bundle	Qty./Bundle
1.5	3/16	4-6	30	2,000
2	3/16	4-6	20	1,000
3	5/16	6-8	40	1,000

Size Ft.	Diam. Inches	Diam. MM	Wt. Lbs./Bundle	Qty./Bundle
4	3/8	8-10	45	500
5	7/16	10-12	35	250

# Bamboo Tripod Cap

Prod. Code	Bag	Box
MSBTCAP	100	1000

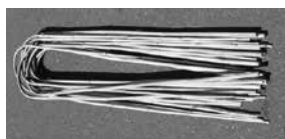

## Bamboo "U" Trellis & Fans

Prod. Codes	Description	Wt./Lbs.
MSBUTO1881N1C	18" "U" Natural (100 bn)	14
MSBUTO248110N1C	24" "U" Natural (100 bn)	19
MSBUTO301012N1C	30" "U" Natural (100 bn)	19
MSBUTO361012N1C	36" "U" Natural (100 bn)	20
MSBUTO421416N1C	42" "U" Natural (100 bn)	40
MSBUTO481416N1C	48" "U" Natural (100 bn)	44

Prod. Codes	Description	Wt./Lbs.
MSBFT18N50	18" Fan Natural (50 bn)	7
MSBFT24N50	24" Fan Natural (50 bn)	10
MSBFT36N50	36" Fan Natural (50 bn)	15
MSBFT48N50	48" Fan Natural (50 bn)	20



# Galvanized Wire Stakes

Basic 1/4" industrial-quality hard wire. Sizes: From 3' to 8' in one foot increments. Sold in bundles of 50. Other sizes available.

Prod. Codes	Wt. Bundle	Prod. Codes	Wt./Bundle
MSST3	26	MSST6	52
MSST4	35	MSST7	60
MSST5	43	MSST8	69





### Bahco PX-M2 Professional Pruning Shears

3/4" cutting capacity. Fixed handle. Three spring tensions. Easy to adjust lockable center bolt – will not loosen while cutting.

Prod. Code

HBTPXM2



### Okatsune 207 Pine Needle Shears

1-7/8" pointed blade. Ideal wherever precise control and very clean cuts are required. For bonsai, floral, propagation and thinning applications. 7-1/2" length.

Prod. Code.

HO207

Wt. Oz.

3.8



### Bahco GS-180-E 15" Grass Shears

Adjustable 180° rotating head. Self-grinding, stainless steel blades. Soft touch, non-slip grip with protective finger loop. Fixed horizontal blades.

Prod. Code

HBTGS180E



### Okatsune 205 Long-Handle Shear

7" blade. Longer blade and handle length make big or little trimming jobs fast and easy. This hedge shears deliver smooth, precise cuts regardless of the foliage you are pruning. 30" length.

Prod. Code

HO205

Wt. Lbs.

1.25



### Bahco PG Ergo Pruners

Ergonomically designed. Xylan-coated head reduces friction for superior cutting. Three handle sizes available.

Prod. Code

HBTPGS2E

Handle Size

Small

HBTPGM2E

Medium

HBTPGL2E

Large



### Okatsune 216 Short-Handle Short-Blade Shear

Short handled, short blade hedge shear. 6" blade, 20" overall length.

Prod. Code

HO216

Wt. Lbs.

1.8



### Bahco P51-SL 23" Hedge Shear

Prod. Code

HBTP51



### Okatsune 217 Hedge Shears

Excellent for shaping and wherever tight quarters limit movement. Total Length 21". 12" handle. 7" blade.

Prod. Code

HO217

Wt. Lbs.

1.25



### Bahco P128-19 Professional Snips

7.5" steel blade. Long, fine cutting head with 1.36" opening. Glass-fibre reinforced plastic handles. Supplied with lightweight holster.

Prod. Code

HBTP12819



### Okatsune 307 Short Pointed Thinning Shear

These shears feature a 1-3/8" pointed blade. The short blade provides for an overall stiffer shear. The added stiffness provides good tip strength and a slightly larger cutting capacity than the 304 model. 7-1/3" length.

Prod. Code

HO307

Wt. Lbs.

0.21



### Okatsune 101 & 103 Pruning Shears

These shears provide cutting performance unmatched by other brands. A unique locking/unlocking feature allows you to open and close the shears with one hand. Blade angle is key to clean cuts.

Prod. Code

HO101

Wt. Oz.

6.2

HO103

8



### Okatsune 304 Pointed Thinning Shears

These shears feature a 1-7/8" pointed blade. The long lasting sharpness makes this an excellent softwood propagation tool.

Prod. Code

HO304

Wt. Oz.

3.4



## Barnel Bonsai, Garden & Floral Scissors

Ideal for all cutting jobs from delicate threads to tin sheeting! Features soft cushioned grips. Portion of inner blade serrated.

Prod. Code	Wt. Oz	Length: In.
HB3300	2.6	6"



## Barnel B200 Professional 8" By-Pass Pruner

Lightweight aluminum die cast handles with vinyl coating, replaceable SK5 steel blade & shock absorbing bumper. Fully adjustable.

Prod. Code	Wt. Oz.
HB200	16

Repair Kit: B-200-K Bumper & Hardware  
**Prod. Code: HB200-K**



## Barnel Z240 Tiger Tooth Folding Saw

9.5" (240 mm) Curved blade. Orchard/Landscape saw.

Prod. Code	Wt. Oz.
HBZ240	16

*\* Blades not under warranty.*



## ARS Tools

Since 1876, ARS Corporation has been defining the state of the art for pruning tools. The tools are sharp, engineered to hold their edge longer, lightweight, well-balanced, and durable. ARS tools are designed for continued professional use with minimal maintenance required, allowing you to spend your time focused on the task at hand rather than on your tools.

Prod. Code	Description
HAHP300L	7" Needlenose Pruner
HAHP130DX	General Purpose Hand Pruner
HAHSK1000L	25.5" Hedge Shear
HALA160ZR305	6' 10" Telescopic Pruner
HALA180L12	Heavy-Duty, Razor Edge 4'
HALA180L21	Heavy-Duty, Razor Edge 7'
HASACAM24PRO	Fixed Saw Arborist 10" w/ sheath
HAHP120EU	Euro Hand Pruner
HAHP310	Curved Blade Pruner
HALA180ZR305	6' 10" Telescopic Pruner, Razor Edge
HAHPKKS4	Hand Pruner



HAHP130DX



HAHSK1000L



HALA180L12 / HALA180L21



HASACAM24PRO



HALA160ZR305

## Corona Shears & Pruners

Prod. Code	Description	Wt. Lbs.
HCFS4310	Corona 5" Mini Shear	.35
HCFS4350	Corona 7-1/4" Thinning Shear	.5
HCBP3130	Corona 6-3/4" Bypass Pruner	.75
HCBP3160	Corona 8" Bypass Pruner	.5
HCBP3180	Corona 8-3/4" Bypass Pruner	.5
HCGS6750	12" Grass Shear	1.0

Born in the California orange groves in the 1920s, Corona tools have been helping generations of agriculturists, gardeners, landscapers, arborists and construction professionals to achieve more, season after season. Our tools are built to last and designed specifically for the day-to-day needs of growers from all walks of life.



HCFS4310



HCFS4350



HCBP3130



HCBP3160



HCBP3180



HCGS6750

## Corona Loppers & Pole Pruners

Prod. Code	Length and Description	Wt. Lbs.
HCWL6321	19" Professional Bypass Vine Lopper	2.0
HCWL6341	22" Professional Bypass Lopper	2.5
HCWL6361	26" Professional Bypass Lopper	2.83
HCWL6461	32" Heavy Duty Bypass Lopper	3.3
HCWL6481	36" Heavy Duty Bypass Lopper	6.0
HCWL6490	37" Super Duty Lopper, 14' Compound Action Tree Pruner	7.0
HCTP6870	curved 13" razor tooth saw, telescopes 7' to 14' Professional Tree Pruner, head only.	6.5
HC6880-8	compound action cuts branches up to 1-3/4"	1.5
HCPS4050	10 1/2" Folding Pruning Saw, 10" saw blade	.66
HCPS7020	14" Folding Pruning Saw, 14" saw blade	1.0
HCPS4081	25" Pruning Saw, Raker Tooth	1.16



HCTP6870



HCWL6490



HCWL6481

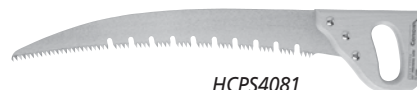

HCPS4081



## Felco 2

Our most popular pruner. Anvil blade with snap-groove, rubber cushion stop. Adjustable. All parts are replaceable.



Prod. Code:	Wt. Oz.
HF02	8.5

Try a Felco pruner and know the joy. The tight, solid feel. The smooth, silky action. It's time to become a Felco Fanatic! Felco pruners will amaze you. Sharp, durable, sturdy, adjustable tools that are easy to repair and maintain. Felco garden tools are everything you need.

We are proud to sell the entire Felco line with all the spare parts and accessories.

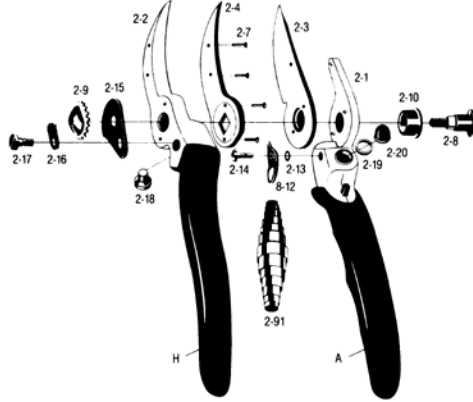

## Felco 2 Replacement Parts

Prod. Code:	Description
HF2-3	cutting blade
HF2-4	anvil blade with rivets
HF2-91	spring – 2 per pack
HF2-93	shock absorber – set of 4
HF2-8	center bolt
HF2-9	nut for center bolt
HF2-10	bushing
HF2-12	thumb catch
HF2-13	washer for thumb catch
HF2-14	screw for thumb catch
HF2-15	catch plate
HF2-16	locking segment
HF2-17	screw for locking segment
HF2-19	edging ring for shock absorber
HF2-35	red plastic coating/blade handle
HF2-36	red plastic coating/anvil handle
HF2-5	rivets

## Felco 4

Similar to the No. 2; same quality cutting blade. Blade adjustment is by the center bolt and nut only.



Prod. Code:	Wt. Oz.
HF04	10

## Felco 5

Similar to the No. 4, but with steel handles. Quality replaceable blade for excellent cutting.



Prod. Code:	Wt. Oz.
HF05	11.2

## Felco 6

Short, narrow blades for cutting close to the stem. Perfect for small and medium hands and for ladies.



Prod. Code:	Wt. Oz.
HF06	7.6

## Felco 7

Rotating handle allows fingers to move naturally, with less effort and maximum comfort when pruning over prolonged periods of time.

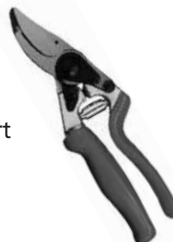

Prod. Code:	Wt. Oz.
HF07	10.7

## Felco 8

Same features as No. 7, but without rotating handle. Blade is angled to be almost an extension of the forearm, therefore improving lever action and increasing cutting power.



Prod. Code:	Wt. Oz.
HF08	8.7

## Felco 9

A left handed shear, with features similar to the No. 8.



Prod. Code:	Wt. Oz.
HF09	8.7

## Felco 10

A left handed shear, with rotating handle and features similar to the No. 7.



Prod. Code:	Wt. Oz.
HF10	10.2

## Felco 11

Similar to the No. 2, the ergonomic hand-fitting design is superbly balanced.



Prod. Code:	Wt. Oz.
HF11	8.5

## Felco 13



Multi-purpose pruning shear with extra long handles. The extended length of the left handle allows for two handed use when cutting thick branches.

Prod. Code:	Wt. Oz.
HF13	15



## Felco Shears

Two-handed shears suitable for pruning thicker branches over a prolonged period.

- **Felco 20** - 17" long, 1-1/2" cutting capacity
- **Felco 21** - 25" long, 1-1/2" cutting capacity
- **Felco 22** - 33" long, 2" cutting capacity

Prod. Code	Wt. Lbs.
HF20	1.75
HF200A60	2.5
HF22	4.5

## Felco F-210C-60 Curved Head Lopper

24" curved head lopper with interchangeable aluminum tube handles – available in three sizes.



Prod. Code:	Wt. Oz.
HF210C60	28



## Felco 600 Folding Saw

Ergonomically designed handle for greater comfort. Cuts branches up to 4" in diameter.

Prod. Code	Wt. Oz.
HF600	5.5

## Felco 611 Pruning Saw/Sheath

Ergonomically designed handle for greater comfort. Cuts branches up to 9" in diameter. A sheath is included.



Prod. Code	Wt. Oz.
HF611	7.8



## Clip-On Holster

All leather with metal clip.

Prod. Code	Wt. Oz.
HFSCO	2

## Belt Holster

Leather, with holes for belt to slip through.

Prod. Code	Wt. Oz.
HFSB	2



## Belt/Clip-On Holster

Leather, with belt holes and a metal clip.

Prod. Code	Wt. Oz.
HFSBC	2



## Felco Lubricant Spray

Biodegradable, protects all types of metals from corrosion.

Prod. Code:	Wt. Oz.
HFF980	1.89

## F-990 Pruner Grease

A high quality grease that reduces wear and tear of moving parts. It is hydrophobic (repels water) and stable at temperatures between -11°F and +248°F. Provides optimum anticorrosion. Non-toxic.

Prod. Code:	Wt. Oz.
HF990	1.89



## Shovels

Prod. Code	Shovel Description	Lift	Blade Size	Handle Length	Wt. Lbs.
HTTA12582	Irrigating Shovel, Round Point	4"	7" x 9-1/2"	47"	4
HTTA12591	Irrigating Shovel, Used for B & B	4"	8-1/4" x 11 1/4"	47"	4.3
HTTA12597	Irrigating Shovel, Used for B & B	4-1/2"	9" x 11-1/2"	47"	4.3
HTTA12728	B & B shovel, Flat Dish, Clip Point	2-1/2"	8-7/8" x 10"	47"	4.2
HTTA12332	Drain spade, Turned Step	—	5-1/2" x 16"	47"	4.5
HTTA12311	Ditch/post spade, Turned Step, D Handle	—	5-1/2" x 16"	27"	4.5
HTTA13095	Flat shovel, Square Point	—	9-3/4" x 11-1/2"	48"	4.5
HTTHANDLE2TK44	Tennessee Hickory Handle for B&B shovel	—	—	48"	1.5
HTTA15372	Fiberglass Round Shovel	—	8-7/8" x 10"	—	7.5
HNFSH68449	Fiberglass Handle - Round	48"	1.5	—	—

FIBERGLASS HANDLES AVAILABLE FOR ALL SHOVELS



HTTA19838

HTTA19836

HTTA25008

## Ames/True Temper Tools

Prod. Code	Description	Ctn Qty/Wt. Lbs.
HTTA19838	Hand Weeder	12/3.6
HTTA19836	Hand Transplanter	12/6
HTTA25008	Planter's Buddy 7-in-1 Tool	12/9.5

Visit our comprehensive website, now including pricing and more products. Easy ordering for your convenience, 24 hours a day. Go to [www.obcnw.com](http://www.obcnw.com) and place your order now!



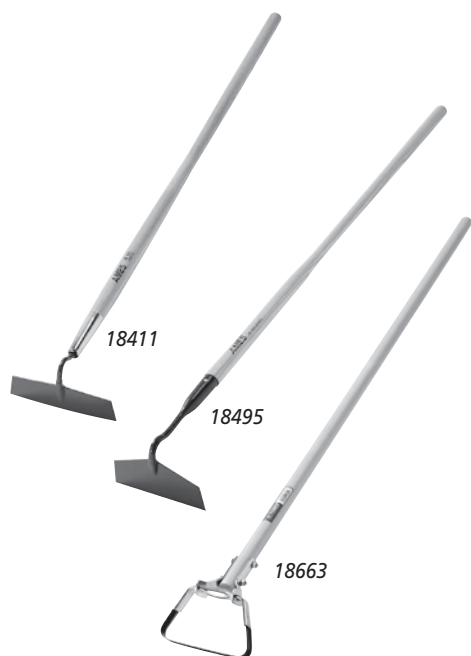

## Hoes

Prod. Code	Hoe Description	Blade Size	Pattern Handle	Wt. Lbs.
HTTA18411	Onion Hoe, Forged Shallow	7" x 1-3/4"	4-1/3" shank	1.9
HTTA18495	Nurseryman's Forged Taper Top	7" x 3-1/2"	4-1/3" socket	2.4
HTTA18663	Scuffle Dual Action Forged Taper Top	6" x 4"	4-1/2" sleeve	2.4

## Farm Tools

Prod. Code	Description	Blade Size	Wt. Lbs.
HTTA18046	Potato Hook, Southern Pattern Forged Steel Head/4 tines	7" x 8-1/2"	4
HTTA16341	Aluminum Scoop, long handle	11" x 13-1/2"	2.9
HTTA16814	Aluminum Scoop, "D" handle	15-3/4" x 20"	3.6
HTTA18233	Regular 5-tine manure fork Bent pattern	11-1/2" x 9 1/4"	3
HTTA18382	6- tine manure fork	12" x 10"	3

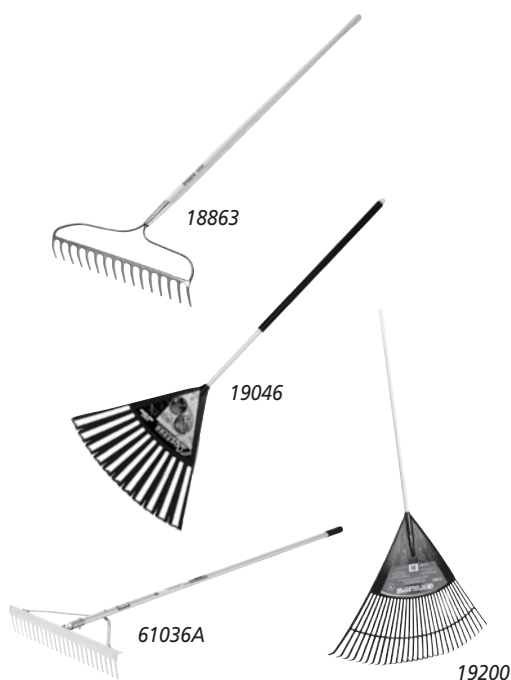

## Rakes

Prod. Code	Description	No. Tines	Width	Handle Lng.	Wt. Lbs.
HTTA1789000	Vinyl-coated aluminum handled rake with hanger end cap	25	18"	48"	2.3
HTTA1789300	Vinyl-coated aluminum handled rake with hanger end cap	11	8"	48"	2.3
HTTA19200	Uniform polypropelene tines retain their shape	26	24"	48"	2.3
HTTA18863	Bow Rake, one-piece forged	15	16-3/4"	60"	3.5
HTTA61036A	Aluminum landscape rake, non-gouging rounded teeth, plug at tip of handle	36	36"	66"	4.3
HTTA19046	Clog free lawn rake, special tines which prevent clogging	11	24"	48"	2.25



## Forged Hedge Shear with 9-1/2" Handle

8-1/2" forged steel alloy blades. Serrated top blade, limb notch in lower blade.

Prod. Code	Wt. Lbs.
HCHS6920	3.0

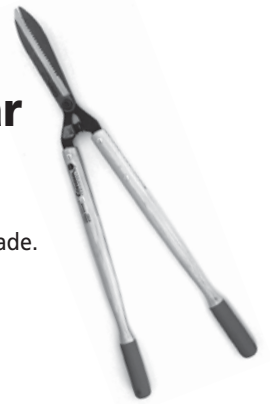

## Forged Hedge Shear with 20" Handle

8-1/2" forged steel alloy blades. Serrated top blade, limb notch in lower blade.

Prod. Code	Wt. Lbs.
HCHS6930	4.0



## Aluminum Loppers

Prod. Code	Cutting Capacity	Wt. Lbs	Overall Length
HCAL8120	1-1/2"	2.0	21"
HCAL8240	2-1/2"	3.5	26"
HCAL8260	2-1/2"	3.5	32"

## Hand Tools Wilcox Tools

Prod. Code	Description	Wt. Oz.	Width	Length
HW101S	12" All-Pro Heavy-Duty Trowel	12	2"	12"
HW251S	11" All-Pro Stainless Trowel	12	3"	11"
HW300S	22" All-Pro Long Handled Trowel	19	3"	22"
HW350S	13" All-Pro Weeder	13	1"	13"



DH12SB



DH15DP



DH12DP



LH15SB

## Wolverine All Steel Spades

Prod. Code	Wt. Lbs.	Desc.	Blade Length/Style
HWWDH12SB	6.71	w/ foot pad 26" D-Handle	12" Straight Bottom
HWWDH12DP	6.71	w/ foot pad 26" D-Handle	12" Diamond Point
HWWDH15DP	7.65	w/ foot pad 26" D-Handle	15" Diamond Point
HWWLH15SB	9.65	w/foot pad 54" Long handle	15" Straight Bottom
HWWFOOTPAD	.35	Rubber Foot pad	—

## Wolverine Stainless Steel Pruners

Professional choice pruners. High quality swedish stainless steel blades and replaceable parts with slip-proof anatomic handles.

Prod. Code	Size
HWPR10	8 1/2" overall
HWPR3	8" overall

## Forged Head Garden Hoe

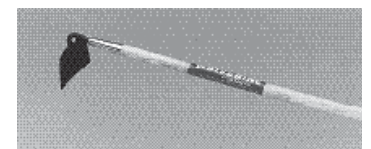

Prod. Code	Wt. Lbs	Size
HWW60GH	5.0	60" Wood

Call or go online for large quantity orders, additional info and current prices.

## Impress-O-Tags

Simply write on **one or both sides** with a ball point pen, pencil, or other sharp object, to deboss (engrave) the tag. Large, 1"x 3-3/8" tags provide plenty of space for you to write on. Your message is **permanent** - it remains legible for years in any environment. The **durable** finish of these metal plant labels will not oxidize or rust, even with prolonged exposure to weather, most chemicals, heat, and dirt. Sturdy aluminum sheet is wrapped and glued around the core and permanently crimped in place, sealing the sides. The tag will not separate. 100 aluminum wire ties (measuring 4" doubled) are included in each box of metal tags.

Prod. Code	Size	Wt. Lbs./100
FLLIT	1" x 3"	0.5

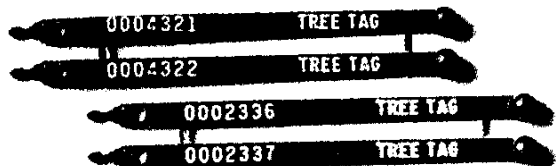
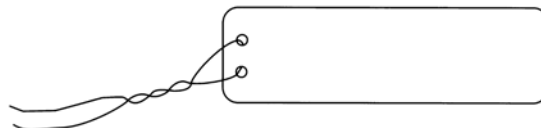

## PID Permanent ID Labels

Numbered and can be imprinted with two lines of information as well. Ideal for those who require tamper proof identification of specific trees. Pre-numbered. White in stock. Other colors available upon request.

Prod. Code	Description	Qty./Bdl.	Wt. Bdl.
FLLPIDP	Printed	100	1
FLLPID	Blank	100	1

## Galvanized Metal Sign Holders

With flanged edges so cards will not blow out. Other sizes available. 25 per box, sold per each.

Prod. Code	Size	Wt. Lbs.
FLLYCH5418	5" x 4" x 18"	.60
FLLYCH7518	7" x 5" x 18"	.64
FLLYCH5430	5" x 4" x 30"	.76
FLLYCH7530	7" x 5" x 30"	.84



## Yard Cards

These information cards can be used as "Silent Salesmen" to help sell your plants. These cards can be written on with a grease pen or permanent waterproof marking pen. The printed cards give all the basic information needed to identify your flowers, nursery stock or vegetables. 100 per bundle.

Prod. Code	Size /Description	Wt. Lbs./100
FLLYC45	4" x 5" Blank	1.5
FLLYC45B	4" x 5" Botanical	1.5
FLLYC45F	4" x 5" Flower	1.5
FLLYC45V	4" x 5" Vegetable	1.5
FLLYC57	5" x 7" Blank	3.0
FLLYC57B	5" x 7" Botanical	3.0
FLLYC57F	5" x 7" Flower	3.0
FLLYC57S	5" x 7" Sale	3.0
FLLYC57V	5" x 7" Vegetable	3.0





## Push-On Tags

20 mil. styrene plastic. Blank push-on labels are used for labeling, color coding, and pricing your plants, trees and shrubs. Weight per 1,000 is 2.5 pounds. 100 per bundle, 1,000 per box. Priced per 1,000.

Prod. Code.	Size	Color
FLLPOBL	1" x 3-3/4"	Blue
FLLPOGR	1" x 3-3/4"	Green
FLLPOOR	1" x 3-3/4"	Orange
FLLPOPI	1" x 3-3/4"	Pink
FLLPORE	1" x 3-3/4"	Red
FLLPOWH	1" x 3-3/4"	White
FLLPOYE	1" x 3-3/4"	Yellow
FLLPODBL	1" x 3-3/4"	Dark Blue

## Blank Bedding Pot Labels

20 mil. styrene plastic. All labels listed are blank. Used for pricing, color coding, and labeling your plants, trees and shrubs. 100 per bundle, 1000 per box. Priced per 1000.

Prod. Code.	Size /Description	Color	Wt. Lbs.
FLLS4WH	4" x 5/8"	White	1.75
FLLS5WH	5" x 5/8"	White	2.25
FLLS5BL	5" x 5/8"	Blue	2.25
FLLS5DBL	5" x 5/8"	Dark Blue	2.25
FLLS5GR	5" x 5/8"	Green	2.25
FLLS5OR	5" x 5/8"	Orange	2.25
FLLS5PI	5" x 5/8"	Pink	2.25
FLLS5RE	5" x 5/8"	Red	2.25
FLLS5YE	5" x 5/8"	Yellow	2.25
FLLS6WH	6" x 5/8"	White	3.0

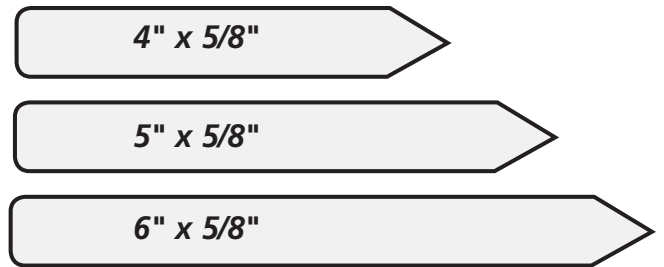

## Wooden Garden Labels

Unpainted. Sold in Quantities of 250/box and 1000/box.

Prod. Code	Size /Description	Wt. Lbs.
FLLW10250	1-1/8" x 10"	5
FLLW10	1-1/8" x 10"	21
FLLW12250	1-1/8" x 12"	7
FLLW12	1-1/8" x 12"	25

Call or go online for large quantity orders, additional info and current prices.



## TXPSX Thermal Printer

The TXPSX models contain the features that make them a best seller in the horticultural market. The ability to print tags up to 24 mil thick, 10" wide, with speeds up to 10" per second make them the ideal nursery printers.

Standard features include Parallel Port, Serial Port, Ribbon Save and a FETHR head (Floating edge type head revolution). The TXPSX printers are available with 4" or 5" print head width.

This printer will print on pot labels, slip-on labels, pressure sensitive labels and yard cards. The rugged powdered-coated industrial strength steel case is designed for harsh environments, and is still attractive for office or store settings. Ribbon, program and labels sold separately. Please see our listings for labels. Call for additional sizes.

**4" TXPSX4    5" TXPSX5**

## Taggit® Pro Labeling Design Software

Whether you need to print bar codes, text, graphic images, color pictures or from a database, Taggit Pro has the features to help you design and print tags and labels with ease. This program will grow with your needs: from entry level dot matrix printing to high speed thermal printing.

- Batch printing
- Full-featured database construction capabilities
- Utilize TrueType fonts, bar codes, preset formats for all OBC Northwest label and graphics capabilities
- Free phone support
- Includes plant database designed by Checkpoint with over 4500 records. This includes Annuals, Perennials, Trees and Broadleaf Shrubs, and is totally editable to add additional varieties or information.

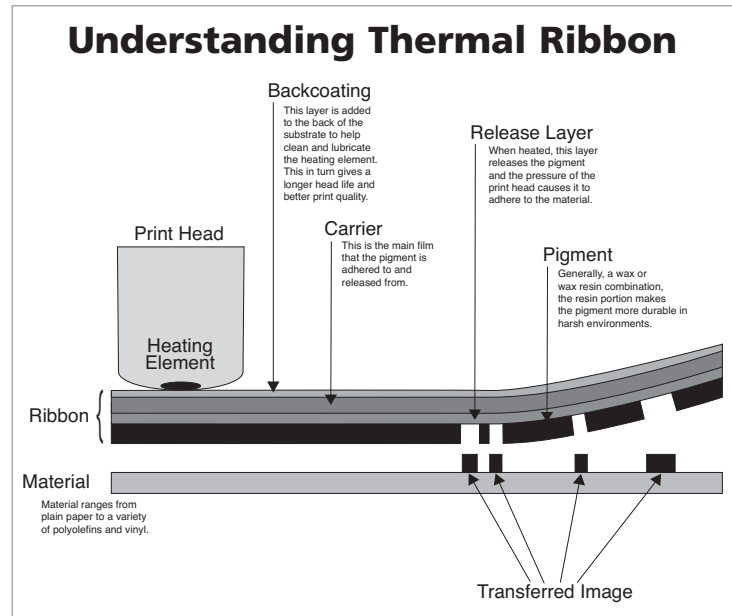

## TXP-Series Printing Accessories

Prod. Code	Description
CALL FOR #	Replacement Coated Print Head, 4"
CALL FOR #	Replacement Coated Print Head, 5"
FLEFTXPSR604	4" Silver Foil (SR604)
FLEFTXPSR605	5" Silver Foil (SR605)
FLEFTXPSR654	4" Gold Foil (SR654)
FLEFTXPSR655	5" Gold Foil (SR655)

## TSC Desktop Printer TTP-247 Series



- Prints up to 4.5" media width
- Up to 7" per second print speed
- Ribbon for printer is 984' long
- Labels for printer
  - Pot tag 1" x 4.5" (2x514IT)
  - Wrap around 3/4" x 5" (TX10775)
  - 1" x 10" (TT10014)
- Various Pressure Sensitive Labels

Prod. Code	Description
FLETP247PLUS	Printer with Bartender Software included
FLETP245SPINDLE	External Spindle
FLETPRI880NWR	Wax/Resin Ribbon for TSC Printer

## Thermal Label Printing & Bar Code Printing

We can print your bar code labels or general plant tags at our factory according to your specifications. There is no long wait for engraving plates as in hot stamp printing. Labels are sold in full roll quantities only. Charges: there is an additional fee of \$1.50 for printing less than 1000 per variety.

# Nursery Marking Pens

Prod. Code	Description	No. Per Box	Weight
FLLPJH	Garden Marker, Black, Fine point	20	1.5
FLLPL	Listo Grease Pencil, Black	12	.25
FLLPLL	Listo Grease Pencil Refill Leads, Black	72	.25
FLLPS	Sharpie Pen, Black, Fine point	12	.25
FLLPSXF	Sharpie Pen, Black, Extra Fine point	12	.25
FLLPGPXW	GPX Markers, White	12	.75
FLLPGPXB	GPX Markers, Black	12	.75
FLLPGPXY	GPX Markers, Yellow	12	.75
FLLPATP	ALL Flex Tag Pen*	1	.75

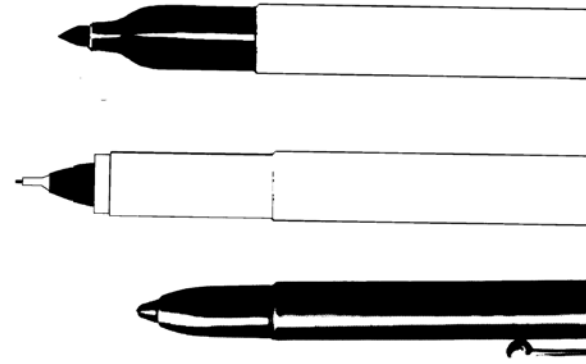

\*Cannot be sold in CA

## Molded Pot Labels

Injection molded stakes are made of heavy duty styrene from .055 to .070 thickness. Priced per 1,000.

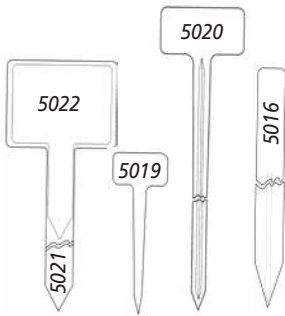

Prod. Code	Face	Shank	Qty./Bdl.	Wt. Lbs./Bdl.
FLL5016	1" x 9.75"	N/A	100	3
FLL5019	1" x 2"	4"	100	1
FLL5020	1.25" x 2.5"	7"	100	2
FLL5021	2.75" x 4"	10"	50	3
FLL5022	2.75" x 4"	3.75"	50	2

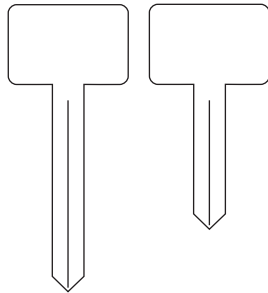

## "T" Stakes

T-Stakes are produced from .030 white polystyrene for easy insertion into most soil. Priced per 1,000.

Prod. Code	Size /Description	Qty./Bdl.	Wt. Lbs.
FLLHS3370BWH	2-1/2" H x 3-3/4" W x 7"	100	1
FLLHS3395BWH	2-1/2" H x 3-3/4" W x 9"	100	1.5

## Pressure Sensitive Labels

Long-lasting labels for outdoor application. Permanent adhesive backing. Ready for use on containers, flats, and most other smooth surfaces.

For additional information on UPC Bar Codes or to obtain your vendor code (first 5 digits of UPC number) or a membership application call: (937) 435-3870 write: Uniform Code Council, Inc., 7887 Washington Village Drive, Suite 300, Dayton, Ohio 45459 or email: info@uc-council.org.

Priced per 1,000.

Prod. Code.	Size	Labels/Roll	Weght/Roll
FLTFT20102WH	2" x 1", 2 up	10,000	5.00
FLTFT40101WH	4" x 1", 1 up	5,000	5.00
FLTFT11233WH	1-3/16" x 2-3/8", 3 up	6,000	5.00
FLTFT20052WH	1-7/8" x 9/16", 2 up	15,000	3.75
FLTFT25372WH	2-1/4" x 3-7/16", 2 up	3,000	6.00
FLTFT20202WH	2" x 2", 2 up	5,000	5.50
FLTFT37251WH	3-5/8" x 2-3/8", 1 up	2,000	7.00

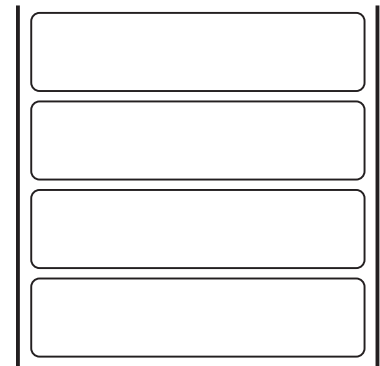



## All-Weather Paper

3" x 5" top spiral, all-weather notebook. Made with all-weather paper, resistant to moisture. Fits in pocket. 100 pages (50 sheets) per notebook.



Prod. Code	Description	Prod. Code	Description
MSAWN935	Green Notebook	MSAWP37	Plastic Barrel Pen
MSAWN935T	Tan Notebook	MSAWP97	Metal Barrel Pen
MSAWCP8511	Copy Paper (200 sheets)		
MSAWCP 9511	Green Copy Paper (200 sheets)		
MSAWN973T	8.5"x11" Side Spiral Notebook - Tan		

## Thermal Slip-on Labels

.010 material.

Colors Available: Goldenrod (**GO**), Green (**GR**), Lavender (**LA**), Lime (**LI**), Orange (**OR**), Pink (**PI**), Red (**RE**), Tan (**TN**), Turquoise (**TU**), White (**WH**), Yellow (**YE**).



Prod. Code.	Size	Color	Labels/Roll
FLTTX1055T_	1/2" x 5"	All Colors	4,000
FLTTX1055TWH	1/2" x 5"	Wht/Yel	4,000
FLTTX1075T_2M	1/2" x 7"	All Colors	2,000
FLTTX1075TWH2M	1/2" x 7"	Wht/Yel	2,000
FLTTX1076T_2M	5/8" x 7"	All Colors	2,000
FLTTX1076TWH2M	5/8" x 7"	Wht/Yel	2,000
FLTTX1077T_	3/4" x 7"	All Colors	2,000
FLTTX1077TWH	3/4" x 7"	Wht/Yel	2,000
FLTTX1071T_	1" x 7"	All Colors	2,000
FLTTX1071TWH	1" x 7"	Wht/Yel	2,000
FLTTX1097T_	3/4" x 9"	All Colors	2,000
FLTTX1097TWH	3/4" x 9"	Wht/Yel	2,000
FLTTX1091TWH	1" x 9"	White Only	1,000
FLTTX1091T_	1" x 9"	All Colors	1,000

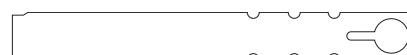
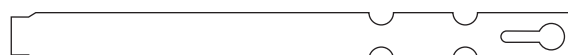

The Thermal Slip-On tags are a great way of identifying your product. Once locked, it will stay on the plant material until removed. Thermal print adheres to the surface for years, and will not fade away. The dry printing process means tags are ready to use as they come off the printer. These Thermal Slip-On tags can be preprinted with the thermal transfer printing method.

## Thermal Pot Labels

.024 heavy plastic.

Colors Available: Lavender (**LA**), Orange (**OR**), Pink (**PI**), Turquoise (**TU**), White (**WH**), Yellow (**YE**).

Prod. Code.	Size	Color	Labels/Roll
FLTPX5156T_	9/16" x 5"	All Colors	2000
FLTPX5156TWH	9/16" x 5"	White Only	2000
FLTPX5166TWH*	9/16" x 6"	White Only	2000
FLTPX5157T_	3/4" x 5"	All Colors	2000
FLTPX5157TWH	3/4" x 5"	White Only	2000
FLTPX5151TWH*	1" x 5"	White Only	1000
FLTPX515T	1" x 5"	All Colors	1000
FLTPX5161TWH	1" x 6"	White Only	1000
FLTPX5161T_	1" x 6"	All Colors	1000
FLTPX5167TWH	3/4" x 6"	White Only	2000
FLTPX51567T_	3/4" x 6"	All Colors	2000
FLTZX5141TWH*	1" x 4-1/2"	White Only	2000

Thermal Pot Tags can be preprinted using the thermal transfer method. Thermal printing adheres to the surface for years, and will not fade away. The dry printing process means tags are ready to use as they come off the printer.

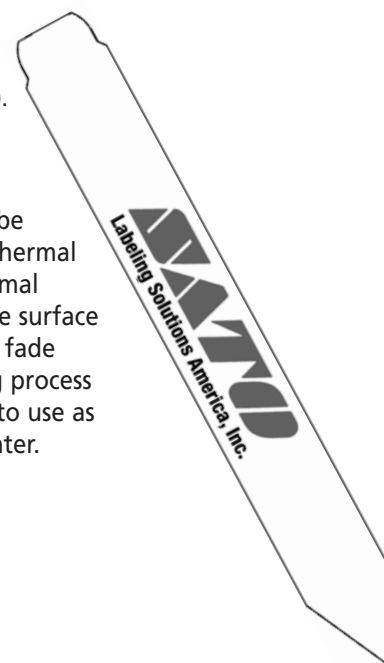

\* Stocked in White Only. Colors available upon request.



## Brushing Shearing Knives

Lightweight, well-balanced knives manufactured in Germany. Highest possible quality stainless steel construction. Expertly ground and honed for optimal cutting life.

Prod. Code	Description	Weight
HXSK1610	10" handle, 16" blade	1 lb.
HXSK1618	18" handle, 16" blade	1
HXSKH-10	10" Shearing Knife Handle	
HXSKH-18	18" Shearing Knife Handle	



## Corona Sharpening Tool

5" super carbide file is ideal for sharpening all blades. No-slip grip for easy use. Fits easily into pockets.



Prod. Code	Wt. Oz.
HCAC8300	1.8

## Tally Meter

This metal plated, attached finger-ring tally meter meets U.S. Government Standards. Counts 0 to 9999 with easy-to-read white numbers on black background. One rotation of knurled knob resets to "0".



Prod. Code	Desc.	Wt. Ozs.
HXTM	Tally Meter	4

## Load/Bird Netting

Prod. Code: SCVOG1669144900

Lasts approximately 1 year. Master roll 4,500'.

Prod. Code	Color	Roll Size Ft.	Mesh Size	Wt. Lbs.
SCVOB75251201000	Black	10' x 1000'	3/4" x 5/8"	32
SCVOB7525120100	Black	10' x 100'	3/4" x 5/8"	3.2

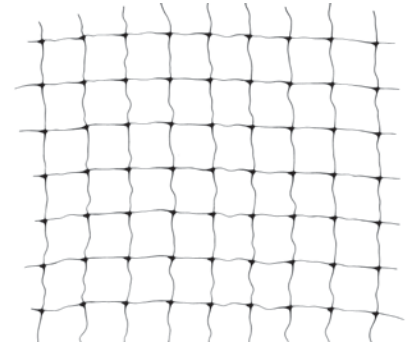

## IRS Shearing Chap

Heavy-duty waterproof Cordura face and back, sandwiching five layers of Ballistic nylon. Single leg chap is fully adjustable. Three velcro straps allow for full leg tension adjustment.

These leg guards don't guarantee full protection of your legs when using a shearing knife.

Prod. Code	Wt. Lbs.
HXSC	2.25

Visit our comprehensive website, now including pricing and more products. Easy ordering for your convenience, 24 hours a day. Go to [www.obcnw.com](http://www.obcnw.com) and place your order now!



6072-1



9841



1441



8215



5458

## Taylor Thermometers

Prod. Code	Description	Dial	Temperature Range	Wt. Oz.
GSTHERM6072	5" Stem Stainless Steel with pocket case	1"	0° to 220° F	2 oz.
GSTHERM5976	4" Steel Soil Test Thermometer	2-1/2"	20° to 160° F	2 oz.
GSTHERM9841	Digital Pocket Thermometer, easy-to-read digital display, 4" stem	1"	-58° to 500° F	2 oz.
GSTHERM1441	Digital Waterproof Max/Min Thermometer. 7 day memory, 2 sensors, indoor/outdoor	—	-20 to 120° F	9.8
GSTHERM8215	8" Stem, Watertight lens and recalibration nut	—1-3/4"	0 to 220° F	1.8
GSTHERM5458P	Max/Min T/R Magnet Reset			6. oz.



## Hanna Instruments pH Testers

Fast, efficient, accurate and portable! Combines all the features users have been asking for and more; easy read LCD, 2-button operation, automatic shut-off and automatic calibration. Waterproof and designed to float. Easily switch between Celsius (°C) and Fahrenheit (°F) readouts.

Prod. Code	Description
MSHI98128	pH/Temperature tester
MSHI98130	pH/EC Combo tester

## UL Listed Propagation Mats

Underwriters Laboratories Inc. (UL) is an independent product safety certification organization.

Rugged and durable with waterproof connectors you can daisy chain up to four mats together. This mat has a 6' power cord and provides constant optimum temperatures for specific crops.

Prod. Code	Description
GSPMMTMDU	60"x 21" Heat Mat (18W)
GSPMMTMDA	60"x 21" Modular Add-On
GSPMMTPRTC	Heat Mat Controller (3 prong)
GSPMMT10009	48"x20" Seedling Mat



## Handi-Reach Handles

Made of hard-drawn aluminum with brass couplings, plastic grip.

Prod. Code	Length	Wt. Lb.
MSDR148GB	48"	.83
MSDR148	48"	.83
MSDR136	36"	.66
MSDR130	30"	.66
MSDR124	24"	.42
MSDR116	16"	.33
MSDR430	30"	.92

#430 comes complete with 30" wand, 400PL water breaker and #45C plastic shut-off.

## Dramm Nifty Nozzles

360° "overhead or on bench" watering. For on the bench watering (cut flowers), use \*BR(Brown), \*GR (Green) or \*GY (Grey) Nifty Nozzles. For overhead irrigation, use \*BL (Blue), \*RD (Red) or \*OR (Orange) Nifty Nozzles

**MSDR360NN\***



## Dramm Misty-Mist Nozzles



Used for 360° overhead mist propagation, raising humidity levels, or for mist cooling. Use Blue/White (**MSDRMMBW**) or Red/White (**MSDRMMRW**) nozzles for propagation and humidity control. Use the high pressure Grey/White (**MSDRMMGW**) for cooling. Weight: 10oz. per 100.

## Dramm Dribble-Rings

For nursery cans and large pots, tropical plantings, B&B stock, greenhouse tomatoes, orchids. A maximum of 400 containers can be watered with the Dribble Rings from a 3/4" supply pipe. Packed 100 per size. Rings listed by Product Codes. 2nd number denotes length of tube.



For 6" & 7" pot	For 8" & 10" pot	For 13" pot
MSDRDR4-12	MSDRDR6-12	MSDRDR85-12
MSDRDR4-24	MSDRDR6-24	MSDRDR85-24
MSDRDR4-36	MSDRDR6-36	MSDRDR85-36
MSDRDR4-48	MSDRDR6-48	MSDRDR85-48
For 16" pot	For 18" & Larger pots	
MSDRDR10-12	MSDRDR13-12	
MSDRDR10-24	MSDRDR13-24	
MSDRDR10-36	MSDRDR13-36	
MSDRDR10-48	MSDRDR13-48	

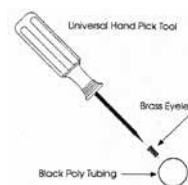

## Dramm Assembly Insert

**MSDRAI**



## Brass Eyelets & Universal Hand Pick Tool

Prod. Code	Description	Weight
MSDRDTMS-E	Eyelet for .060 & .045 I.D.	70 oz. per 100
MSDRPT	Universal Hand Pick Tool	2.1 oz.

**Note:** The outer Diameter (O.D.) of the green and brown tubes are exactly the same (only the inside Diameter (I.D.) is different - both sizes use the DTMS-E Eyelet.

# Dramm Products



## 400 Water Breaker

**MSDR400**

Cast aluminum with cast-in brass threads.



## 400PL Water Breaker

**MSDR400PL**

Blue cyclac plastic with aluminum face disc.



## 170 Water Breaker

**MSDR170**

All aluminum with brass coupling. Use when low pressure prevails. Great for 4" pots.



## 170PL Water Breaker

**MSDR170PL**

Same as the 170 water breaker except it is made of unbreakable black cyclac plastic with aluminum face disc.



## 750 Lemonhead™ Water Breaker™

**MSDR750PLC**

Cyclac plastic, stainless steel. Protective rubber ring. Ultra soft with lower flow.



## 1000BP "Redhead" Water Breaker

**MSDR1000BP**

Ultra soft flow for plugs, cuttings, and bonsai.



## Green Narrow Pattern Water Breaker

**MSDR1000PLN**

Perfect for focused watering where more control is required.



## Orange Wide Pattern Water Breaker

**MSDR1000PLW**

Throws a wider pattern than the standard Redhead, offering the ability to cover more area with a soft, gentle flow.



## Dramm Products



**300 Brass Shut-Off**  
**MSDR300**  
 3/4" Female hose threads. 3/4" Male hose threads.



**300ALC Aluminum Shut-Off**  
**MSDR300ALC**  
 3/4" Male to Female hose threads.



**235 Plastic Dual Shut-Off**  
**MSDR235**  
 Cyclac plastic dual shut-off.  
 Female/Male hose threads.



**65C Lever Activated Shut-Off**  
**MSDR65C**  
 Designed for quick and easy watering.  
 Higher water flow than comparable triggers.  
 Great with Dramm 170 Water Breaker Nozzle.



**510 Seedling Nozzle**  
**MSDR510**  
 Made of cadmium plated brass. Puts out an extra fine spray for seedlings.



### Fogg-It "Water Fog" Nozzles

Heavy-duty, solid brass jets deliver a super-soft mist that is ideal for greenhouse use, spraying delicate flowers, newly planted lawns or seed beds. Weight 6 oz.

Prod. Code	Description	GPM
MSFSSF	super superfine	1/4
MSFSF	superfine	1/2
MSFF	fine	1
MSFL	low volume	2
MSFH	heavy volume	4

### 45 Plastic Shut-Off

**MSDR45**  
 Cyclac plastic shut-off. Female/Male hose threads.



### 540BC Brass Rose

**MSDR540B**  
 Extra-wide spray pattern allows you to increase the speed of hand watering. Great for watering bedding plants, pots.



### 14700 One Touch Shut-Off Valve

**MSDR14700**  
 Offers precision fingertip control for all your watering needs.



### 74C Polyprop Shut-Off Valve

**MSDR74C**  
 Made with polypropylene to be very durable and corrosion resistant. More durable than other plastic valves. Lightweight and offers a full flow.



### Fogg-It Pot Waterer

Combination watering device with convenient thumb lever shut-off valve and two interchangeable heads. Attaches to standard garden hose. Chrome plated copper angled spout. Thumb valve designed for ergonomic comfort.

Prod Code	Size/Description	Wt. Lbs.
MSFW14	14" wand	1.0
MSFW24	24" wand	2.0
MSFTV	thumb valve	.5

## Gilmour Products

### Deluxe Fan Spray



Prod. Code	Desc.	Wt. Oz.
MSGI305	with shut-off valve	4

### Solid Brass Twist Nozzle



Prod. Code	Weight
MSGI528	8 oz.

### Solid Brass Stream Nozzle



Prod. Code	Weight
MSGI06BJ	4 oz.

### Hose Washers



Prod. Code	Desc.	Weight
MSGI01RW	Rubber	.2 oz.
MSGI02FW	Filter	.4 oz.

### Hose Menders

For mending all standard 5/8" to 3/4" plastic or rubber garden hose.



Prod. Code	Desc.	Weight
MSGI01M	Male End	2 oz.
MSGI01F	Female End	2 oz.
MSGI01HM	Hose Mender	2 oz.

### Plastic Quick Couplers



Prod. Code	Desc.	Weight
MSGI29Q	Male/Female	2 oz.
MSGI29QF	Female	2 oz.
MSGI39Q	Faucet M/F	2 oz.

### Brass Quick Couplers



Prod. Code	Desc.	Weight
MSGI09QC	Male/Female	4 oz.
MSGI09QCM	Male	3 oz.
MSGI09QCF	Female	3 oz.

### Gilmour Zinc "Y" Couplers



Prod. Code	Desc.	Weight
MSGI15	Zinc "Y" Connector	5 oz.

### Gentle Shower

Gentle shower spray for delicate plants and seedlings.



Prod. Code	Desc.	Weight
MSGI314	Gentle ShowerHead	9 oz.

### Gates Flexogen Water Hose

Prod. Code	I.D.	Length Ft.	Wt. Lbs.
MSG58025	5/8"	25	4.75
MSG58050	5/8"	50	6.25
MSG58075	5/8"	75	12.10
MSG58100	5/8"	100	16.00
*MSG58250	5/8"	250	39.00
MSG34025	3/4"	25	5.25
MSG34050	3/4"	50	10.00
MSG34075	3/4"	75	15.25
MSG34100	3/4"	100	22.00
*MSG34250	3/4"	250	52.00



\* uncoupled



## KPC48 Push Cart

The Push Cart from King.

- Dimensions: 24" x 48" x 17"
- Expanded metal deck
- Powder coated finish
- Rear wheels turn and swivel in all directions
- Tube tires
- Weight capacity: 1,000 lbs.

Prod. Code	Description	Weight
HKCKPC48	Push Cart	83
HKCKPC48D	Top Deck	N/A



## KRW Nursery Wagon

The KRW nursery wagon is available in three sizes.

- Weight capacity: 500 lbs.
- 4.10 x 4, 2-ply tubeless tires (KRW36 / KRW48)
- 4.8 x 8-16 tires (KRW72)
- 36" handle

Prod. Code	Description	Weight
HKCKRW36	KRW 21" x 36" wagon	70
HKCKRW48	KRW 22" x 48" wagon	94
HKCKRW72	KRW 36" x 72" wagon	140



## KC-60 Nursery Cart

Versatile cart with expanded metal deck.

- Size: 25" x 60" I.D.
- Weight capacity: 500 lbs.
- 4.8 x 8-16 tires
- Available with or without foot
- Support foot-handle operated

Prod. Code	Description	Weight
HKCKC60F	KC-60 with foot	95
HKCKC60	KC-60 without foot	95



## KT-H10 Tracking Trailer

Heavy-duty tracking trailer with automotive type 4-wheel steering. This trailer offers greater stability than 5th-wheel type axles.

- Size: 4' x 10'
- Rated at 2000 pounds
- 18 x 8.5 x 8 turf tires
- Hubs and roller bearings
- Comes with 3/4" plywood deck;
- Special order expanded metal deck
- Upper deck available, 2" angle iron with plywood or expanded metal deck. 21" or 24" from bottom deck.

Prod. Code	Description	Weight
HKCKTH10	Trailer w/ wood deck	450
HKCKTH10EX	Trailer w/ exp. mtl. deck	450
HKCWDECK	Upper deck w/wood	110
HKCSDECK	Upper deck w/ exp. mtl.	110



## Harrell's NPK

### 14-14-14 with Polyon Coated Homogeneous High Nitrate Fertilizer

Prod. Code FZA141414

A 3 to 4 month professional controlled release homogeneous nursery fertilizer. This formulation is high in the nitrate form of nitrogen. All of the nutrients in Apex Nursery Supreme 14-14-14 are combined within each uniformly coated pellet, insuring precise distribution and release.

Benefits:

- Provides improved safety of the Polygon Reactive Layer Coating controlled release technology.
- Release of nutrients is controlled by osmosis and is not affected by media type, moisture level, pH, or microbial activity.
- Osmotic release of nutrients with Polygon is predictable and reliable.
- 50# bag; 40 bags/pallet

### Apex (Evergreen) 21-7-8 with Polyon and Micronutrients

Prod. Code FZA2178

A professional, high-quality warm climate 8 to 9 month fertilizer, cool climates (Pacific Northwest) 12 to 15 month fertilizer, with all the nutrients coated for optimum safety and performance.

- Provides safety of the Polygon Reactive Layer Coating controlled release technology.
- Each individually coated nutrient granule has a coating thickness calibrated to meter specific nutrient levels at the growing temperature consistent with plant demand.
- Nutrient release is not significantly affected by media type, moisture level, pH, or microbial activity.
- 50# bag; 40 bags/pallet

### Apex (Super Iron Topdress) 21-5-6



#### with Polyon and Micronutrients and zeothix 265

Prod. Code FZA2156

A professional, cost effective 3 to 4 month controlled release fertilizer for greenhouse, bedding plants, and landscape areas.

- 92% of the nitrogen is coated slow release for safe predictable response.
- Low salt index 0-45-0 and Sulfate of Potash.
- Release of nitrogen by osmosis
- 50# bag; 40 bags/pallet

## Apex NPK

Prod. Code FZA18612

All nutrients are formulated into homogeneous granules for even distribution. Nutrients are coated for long-term feeding. All nitrogen is provided in ammoniacal and nitrate forms. No micronutrients added. 18-6-12 (18-2.5-9.9) 8-9 months formulated for a steady release of nutrients. Ideal in warmer climates. Will not over-release in hot conditions.

50# bag; 40 bags/pallet

# JACK'S PROFESSIONAL®

## JACK'S Professional Water Soluble Fertilizers

### 20-20-20 General Purpose

Prod. Code FZP202020

One of the most versatile products in the Peters® line. Used successfully for soilless mix culture. Potential acidity counteracts moderate water alkalinity. May be employed as a foliar spray. 25 lbs./bag, 84 bags/pallet. Maximum solubility: 3 lbs. 8 oz./gal.

### 20-10-20 Peat-Lite Special

Prod. Code FZP201020

One of the most versatile formulas for year-round growing. Acidic nature counters undesirable water alkalinity. High nitrate to ammonium ratio. Non-caking feature aids in storage and prevents hardening. 25 lbs./bag, 84 bags/pallet. Maximum solubility: 4 lbs./gal.

\*Note: For WILL CALL customers ONLY

### 9-45-15 Plant Starter

Prod. Code FZP94515

Ideal for all transplants, including agricultural and floricultural transplants in both greenhouse and field cultures. Especially beneficial when soil temperatures are low. High phosphorus level stimulates rapid root growth. Can be used as a drench to get plants started. 25 lbs./bag, 84 bags/pallet. Maximum solubility: 2 lbs. 8 oz./gal.





## OBC Northwest Nursery Mix #1

Sold in 2 cu. ft. loose bags, 60 cu. ft. bulk bags (requires a forklift for unloading), and 30 & 60 yard bulk loads. Mix is to be used in 1 gallon or larger containers. Contains: 70% fine bark, 20% mulch and 10% pumice. Wetting agent added. 40 Bags per pallet.

Prod. Code	Description	Bag Wt. Lbs.
PMOBCNM1	2 cu. ft. loose	40
PMOBCNM1BB	**60 cu. ft. bulk bags	1,200
PMOBCNM1BY	bulk yard (cost plus freight)	—

\*\* Fork Lift or Tractor with Forks Required for Unloading all Bulk Bags

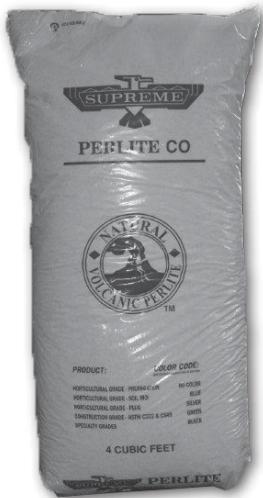

## Soil Amendments

### Perlite (30-36 Bags Per Pallet)

A lightweight amendment for propagation and potting use. Improves aeration and drainage while retaining nutrients. Neutral pH, sterile. Choose from three grades:

- **Soil Mix** – Finest mix.
- **Propagation Mix** – more coarse than Soil Mix. Used in general propagation.
- **Horticultural Mix** – Course grade. Good for plugs.

Prod. Code	Description	Bag	Weight
PMP5M	4 cu. ft. soil mix	plastic	35 Lbs.
PMPPG	4 cu. ft. propagation	plastic	35 Lbs.
PMPXLP	4 cu. ft. horticultural	plastic	21 Lbs.



### Vermiculite (30 Bags Per Pallet)

Made up of granules of a unique lightweight mineral with countless cells or pockets that hold and release air and water as plants need them. Breaks up heaviest clay soil and enables sandy soil to hold moisture. Plants emerge from soil more readily and develop stronger roots.

Prod. Code	Description	Bag	Bag Wt. Lbs.
PMV35	3.5 cu. ft. bag	woven polypropylene	40

### Peat Moss (30 Bags Per Pallet)

Prod. Code	Description/Grade	Bag Wt. Lbs.
PMPMGG38TH	3.8 cu. ft. super course	55

### Coco Fibre (40 Bags Per Pallet)

Loose fill

Prod. Code	Description/Grade	Bag Wt. Lbs.
PMOBCCF	2 cu. ft. bags	22



# OBC Northwest Soil Mixes

## Seedling Mix #1

Contains: 60% peat moss, 35% fine perlite and 5% washed sand. Wetting agent added. Free of weeds, disease and insects. Sold in 2 cu. ft. bags (40 bags/pallet) and 60 cu. ft. bulk bags.

NOTE: The 60 cu. ft. bulk bag equals 2.2 yards and will require a forklift for unloading.

Prod. Code	Description/Yield	Weight
PMOBCS1	2 cu. ft. loose	35 Lbs.
PMOBCS1BB	60 cu. ft. bulk bag	900 Lbs.



## Professionals Choice Organic Potting Soil (OMRI Listed)

Contains: 20% regular pumice, 20% fine bark, 20% coir, 20% peat moss and 20% perlite, limestone, dolomite, gypsum, wetting agent.

Prod. Code	Description/Yield	Bag Wt. Lbs.
PMDBCPCOPS	2 cu. ft. loose	39
PMOBCPCOPSBB	60 cu. ft. bulk bag	1260



## Bedding Plant Mix #2

Contains: 35% grower-grade peat moss, 32% mulch, 25% perlite and 8% vermiculite. Wetting agent added. Sold in 3 cu. ft. (compressed into 2 cu. ft. bags, 40 bags/pallet), 60 cu. ft. bulk bags and 30 and 60 yards bulk.

NOTE: The 60 cu. ft. bulk bag equals 2.2 yards and will require a forklift for unloading.

Prod. Code	Description/Yield	Bag Wt. Lbs.
PMOBCBP2	3 cu. ft. (compressed into a 2 cu. ft. bag)	40
PMOBCBP2BB	60 cu. ft. bulk bags	1,200
PMOBCBP2BY	Bulk yard (*cost per yard plus freight)	



## Hanging Basket Mix

Increased water-holding ability for baskets. Contains: 50% mulch, 20% peat moss, 20% coconut fiber and 10% Perlite. Wetting agent and diatomaceous earth added. Sold in 2 cu. ft. bags (40 bags/pallet) and 60 cu. ft. bulk bags.

NOTE: The 60 cu. ft. bulk bag equals 2.2 yards and will require a forklift for unloading.

Prod. Code	Description/Yield	Bag Wt. Lbs.
PMOBCHBDE	2 cu. ft. loose	38
PMOBCHBDEBB	60 cu. ft. bulk bag	1,185

## Greenhouse Mix #3

Contains: 45% mulch, 25% peat moss, 20% pumice, 5% vermiculite and 5% perlite. Wetting agent added. Free of weeds, disease and insects. Sold in 2 cu. ft. bags (loose fill / 40 bags/pallet), 60 cu. ft. bulk bags (requires a forklift for unloading), and 30 and 60 yards bulk.

NOTE: The 60 cu. ft. bulk bag equals 2.2 yards and will require a forklift for unloading.

Prod. Code	Description/Yield	Bag Wt. Lbs.
PMOBCGH3	2 cu. ft. loose	61
PMOBCGH3BB	**60 cu. ft. bulk bag	1,500
PMOBCGH3BY	Bulk yard (*cost per yard plus freight)	



## Warren's T-7II Spreader

Warren's T-7II weighs less than 6 pounds when empty and holds up to 20 pounds of seed, herbicide or fertilizer. Tough, high-impact polyethylene and stainless steel construction provides trouble-free operation with minimum care.



Precision flow rate control is fully adjustable during operation so you can tailor application to fit the toughest jobs.

Prod. Code	Wt. Lbs.
HMSPW	6.0

## E-Z Feeder

Use dry or free-flowing material.

- Fast – 2,275 feedings per hour
- Versatile, accurate and economical
- Will not fracture pellets
- Corrosion resistant and easily cleaned
- Lightweight



Prod. Code	Weight	Feed Measure Tsp.
MSMEZFC	2lbs., 4 oz.	1-1/2 to 7-1/2
MSMEZFA	2lbs., 4 oz.	1/2 to 4
MSMEZFMM*	2lbs., 4 oz.	1/12 to 1

\* not recommended for fertilizer

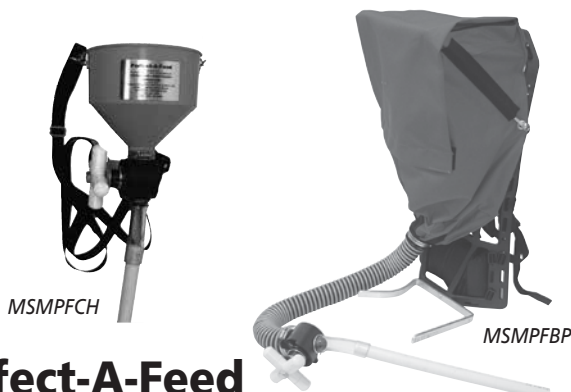

## Perfect-A-Feed

5-quart dispenser or 25 pound capacity backpack dispenser. Fast, easy measured operation. Unit includes 1 teaspoon and 1 tablespoon drum.

Other measuring drum sizes available:  
1/8 teaspoon, 1/3 teaspoon, 2/3 tablespoon

Prod. Code	Description	Weight
MSMPFCH	5 qt. capacity	3 Lbs.
MSMPFBP	25lb capacity	11 Lbs.



## Dramm Syphonject

The Dramm Syphonject is a convenient device capable of diluting concentrated, water soluble plant food or chemicals through your garden hose. Syphonject draws up concentrated solution through a small suction tube and dilutes it at the rate of 16:1 into the passing water stream inside the housing. 3/4" male & female hose threads.

Product Code	Qty/Case	Weight
MSMS	12	8 oz.

## Acme Gravity-Flow Type Spreader

Spread granular herbicides, fungicides, insecticides, and fertilizers.

- Adjustable swath width from 2 inches to 3 feet
- Flow rate is easily varied by changing walking speed; by adjusting swath width; by changing the disk size.
- Three sizes of disks are supplied
- No metal parts to corrode or rust



Prod. Code	Empty Weight	Full Weight
HMSPC	6 oz.	2 lbs.



## Fertil Dispenser

The Fertil Dispenser Granular Top Dresser is ideal for top dressing containerized plants and in-ground trees and shrubs. Fast, accurate and efficient; will fertilize up to 1500 plants an hour and apply 2 to 25 grams per dose. Holds up to 20 quarts. Includes strap pads, spreading paddle for larger target areas and a dispenser head cover for wet conditions.

Product Code	Weight
HMSFT	6.8 Lbs.

Visit our comprehensive website, now including pricing and more products. Easy ordering for your convenience, 24 hours a day. Go to [www.obcnw.com](http://www.obcnw.com) and place your order now!

## Dosatron Fertilizer Injectors

Non-Electric Proportional Fertilizer Injectors. The results: an accurate and uniform feeding of fertilizers, fungicides, acids and more in your irrigation water. Dosatron fertilizer injectors are of use to greenhouse growers, nurserymen, landscapers, vegetable growers. Irrigate with: sprinklers, drip trickle, microjet, mist or fog, tape, etc.

### Li'l Bud-D DosaCart

Prod. Code MSDLBD

- Polyethylene construction
- 5-gallon bucket
- 10" no flat tires for maximum mobility
- Dimensions: 44.5" high, 19" wide (wheel to wheel), and 22" deep



### Dos-A-Cart

Prod. Code MSDDC

15 gallon, transparent polyethylene tank. Crash bar to protect unit from damage. 10" specialty tires. Drain valve at bottom for easy clean-up. Weight: 42 lbs.



### 14 GPM — D14M22VFII

Prod. Code MSD14

Higher flow rate (14 GPM vs. 11 GPM). Simplified motor piston has only 17 parts (vs. 52 parts in the previous unit). Chemical-resistant housing, easy-to-read ratio selector and accurate fertilizer injection. No tools required for easy, stress-free maintenance. This model replaces the 11 GPM unit. Weight 6 lbs.



### Dos-A-Cart Plumbing Kit

Prod. Code MSDPHSPK58

Includes everything you need for a quick and easy installation onto the Dosatron Dos-A-Cart. Weight: 5 lbs.



### Dosatron Filters\*

200 mesh (80 micron) filters are recommended by Dosatron. Kits available. Sold separately.

MSDF14	14 gallon
MSDF20	20 gallon
MSDF40	40 gallon
MSDF100	100 gallon



\* Units used without a filter, voids warranty

### Dosa-Klean

Cleans injector parts and maintains injector performance when soaked in product for 12-24 hours. Quick and easy to use.

### 11 GPM – D25F1VFII

Prod. Code MSD11F

11GPM Fixed rate. Designed for poor water quality due to sugar, sand, iron or hard water. Easy to install and maintain. Bypass, mounting bracket, suction tube, strainer and weight is included. Weight: 5 lbs.



### 20 GPM — D45RE15VFII

Prod. Code MSD20

Non-electric proportional dispenser. Flow rates of 0.5 to 20 gallons per minute; injection ranges from 0.2% to 1.5%. External injection available for aggressive liquids. Weight: 8 lbs.

- Built-in Bypass
- Technologically advanced motor design
- Externally adj. injection stem



### 40 GPM — D8R

**NEW AND IMPROVED!**

Prod. Code MSD40D8R

The NEW D8R - 40 GPM fertilizer injector was designed using new technology and innovation, making it the *must have* fertilizer injector. The NEW 40 GPM has a polypropylene housing and can easily inject fertilizers, pesticides, and caustic chemicals accurately with a flow rate of 2.2 to 40 GPM, an injection ratio of 1:500 – 1:50, and a pressure range of 2 to 110 psi.

- Improved chemical resistant housing
- Enhanced UV resistance
- Allows injection of corrosive chemicals
- Easy-to-adjust injection rates
- Easy-to read graduated scales
- 1 1/2" NPT inlet/outlet
- Built-in filter and anti-siphon valve



Includes: mounting bracket, suction hose, weighted strainer, and operating manual. Optional bypass available.

### 100 GPM — DS20SVFII

Prod. Code MSD100

The largest of the Dosatron Injectors. Its hardness is equalled only by its precision. It can be manifolded for larger flow rates or be used on a by-pass system. It can also be mounted in a series. Externally adjustable ratios from 1:500 to 1:50. Side injection and built-in mixing chamber. Operates at low-flow and low-pressure. Weight 47 lbs.

- By-pass
- Portable
- Anti-siphon valve
- Pressure range 2 to 120 psi



### Dosatron Check Valves

Protection from backflow or water hammer.

MSDCV34	3/4"	for 14 gpm
MSDCV100	1"	for 20 gpm
MSDCV112	1-1/2"	for 40 gpm
MSDCV2	2"	for 100 gpm







## Solo Back Pack Sprayer 475

Prod. Code: HMSS475

Diaphragm Pump. Minimum maintenance, large spraying capacity, even liquid distribution with low energy expenditure and low weight due to top quality UV plastics. 4 gallon capacity.

Weight: 11lbs.

## Safety Goggles/Glasses

Prod. Code: MSMGOGGLES



### Goggles Feature:

- Wrap-around lens - offers wide angle of vision.
- Vertical vent system - promotes air circulation over lens surface. Helps prevent fogging.
- Wide back opening - allows goggles to fit easily over large safety glasses.
- The wide nasal flare angle - allows the goggles to be worn with most half-mask respirators.



### Safety Glasses:

Prod. Code: MSMGS

Polycarbonate lenses, large, protective side shields and brow guard. Handsome, aviator styling that almost guarantees your employees will want to wear them. Eye protection when working with wood, machinery, etc.



## Kleen Guard GP Coveralls

The fabric breathes like cloth. Use in general applications. Offers effective protection against many particles and water-based liquids. White with elastic wrists and ankles. Attached hood.

Sizes: Medium, Large, X-Large, XXL, XXXL

Prod. Code	Description	No. Per Case
MSMCO_ _	coveralls	24
MSMCOXXXL	coveralls	20

**OBC NORTHWEST, INC.**  
Nursery & Greenhouse Supplies

Your Complete Source for  
Greenhouse, Nursery and  
B&B Supplies and  
Accessories since 1954





## Woods Rooting Compound

A special concentrated liquid formulation that offers the commercial grower a safe, effective and economical way to take advantage of rooting stimulants.

Prod. Code	Size	Wt.	Case Amount
CHW4OZ	4 oz.	4 oz.	24
CHWP	PINT	16 oz.	12
CHWG	GALLON	8 lb.	2

## Hormex #1 Rooting Compound

Use Hormex #1 for easy-to-propagate plants such as common shrubs and greenhouse plants.



Prod. Code	Wt. Per Box	Boxes/Case
CHHX1	1 lb.	12

## Hormex #3 Rooting Compound

Use Hormex #3 for rooting woody and semi-woody plants and easy-to-propagate evergreens.

Prod. Code	Wt. Per Box	Boxes/Case
CHHX3	1 lb.	12

## Hormex #8 Rooting Compound

For rooting difficult to propagate plants such as evergreens and dormant leafless cuttings.

Prod. Code	Wt. Per Box	Boxes/Case
CHHX8	1 lb.	12

## Hormex #16 Rooting Compound

Prod. Code	Wt. Per Box	Boxes/Case
CHHX16	1 lb.	12

## Vapor Guard

Anti-transpirant concentrate. A water emulsible organic concentrate for use on plants to retard water transpiration and maintain healthy foliage.

Prod. Code	Size	Weight	No./Case
CHVG	1 gal.	8 Lbs.	4

## Sticky — Yellow Insect Traps

Sticky Strips are bright yellow plastic sheets, coated on two sides with a specially formulated sticky goo. Hang them or fasten them in place, peel off the protective coverings and they'll catch insects until they are covered with insects or debris. Many insects are attracted to the color yellow: Aphids, Fungus gnats, Whiteflies, Leafminers, Carrot rust flies, Thrips and many others. They are inexpensive and disposable, 3" by 5".

Prod. Code	Wt. Per Box	Boxes/Case
CHSSYE	1 lb. 12 oz.	10

## Gopher & Mole Traps

Prod. Code	Description
MSTC601	Gopher Trap
MSTC603	Mole Trap

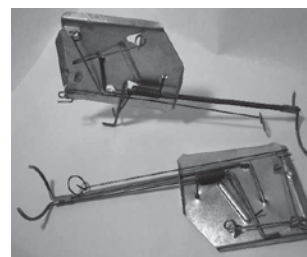

Visit our comprehensive website, now including pricing and more products. Easy ordering for your convenience, 24 hours a day. Go to [www.obcnw.com](http://www.obcnw.com) and place your order now!

## Water Shed Nitrile Rain Wear

Top-of-the-line rain wear, considered by many to be the most comfortable, lightweight and durable rain wear available. Material: Nitrile coating, laminated to 200 denier nylon. Construction: Raglan sleeve jacket with fleece collar and storm flap. Bib overalls with heavy-duty suspenders. Nylon hardware is non-conductive, rust proof and spark proof. Sealed, double stitched lap seams for extra strength.

Colors: Yellow (Y), Blue (B), Forest Green (G)  
 Sizes: Small through XXX-Large



Prod. Code/Size/Color	Description
MSRGWJ_ _	30" jacket
MSRGWP_ _	bib overalls
MSRGWH_	snap-on hood
MSRGW_XXL_	XXL
MRSRGW_XXXL_	XXXL

## PVC Rain Gear

### 3-Piece Set Jacket, Hood & Bib-Overall Pants

Medium (M), Large (L), X-Large (XL),  
 XX-Large (XXL), XXX-Large, Yellow



Prod. Code	Description
MSRGPVC_	3-piece set

## Vinyl Aprons

Prod. Code	Description
MSMAPRON45BL	45" in length, 7.5 mil.



## All-Weather Paper

3" x 5" top spiral, all-weather notebook. Made with all-weather paper, resistant to moisture. Fits in pocket. 100 pages (50 sheets) per notebook.



Prod. Code	Description
MSAWN935	Green Notebook
MSAWN935T	Tan Notebook
MSAWCP8511	All weather copy paper (200 sheets/pkg)
MSAWCP9511	Green, all weather copy paper (200 sheets/pkg)

## Protective Gloves

### Atlas 370 Nitrile Glove

- Tough nitrile coating, with breathable, nylon liner
- Machine washable
- Small & Medium: Pastel Colors, Medium & Large: Black
- Sold 12 per bundle



Prod. Code	Description
MSMGLAN_	Atlas 370 Nitrile
MSMGLANG_	Atlas 370 Nitrile Garden

## Atlas Rubber Gloves

Breathable knit back, rubber palm and fingers provide excellent fit and comfort. Good for transplanting. Available in blue (unlined) or gray (lined). Sizes S - M - L - XL.



Prod. Code	Description
MSMGLBR_ _	Blue, Unlined Glove
MSMGLBRL_ _	Gray, Lined Glove

## Cowhide Drivers Glove

Full grain cowhide. With or without strap. Sizes M - L.



Prod. Code	Description
MSMGLD_	No strap

## Cotton Glove Liners

MSMGLCL



## Gold Gripper Gloves

Prod. Code	Description
MSMGLGG_	Sizes S-M-L-XL



## Jersey Gloves

Prod. Code	Description
MSMGLBJ	Sizes S-M-L-XL



## Neoprene Gloves

Prod. Code	Description
MSMGLN_	Sizes S-M-L-XL



## Nitrile Disposable

Prod. Code	Description
MSMGLND_	Sizes S-M-L



# OBC Northwest Inc. is your Greenhouse Specialist!



- OBC Northwest Inc. provides full service for your greenhouse construction needs.
- We evaluate your requirements and work with you to find the best possible solutions.
- Many styles from various manufacturers; from gutter connected ranges with hard or soft coverings, retractable roof, retractable heat/shade systems and cold frames. Let us build your greenhouse for you!

Oregon Contractors No. 127055 • Washington Contractors No. OBCN01\*022CR



OBC Northwest offers a full range of Greenhouse Construction Services

- **Semi-Gable 30' wide**
- **Semi-Quonset 20' wide**
- **Quonset Overwintering Cold Frames**



**Customized To Your Needs!**

OBC uses the highest quality galvanized steel pipe in the construction of all our greenhouses. High quality mechanical steel provides extra resistance to rust and corrosion – inside and out! Easy to follow installation instructions. Hardware parts are included. Lumber for end framing and side boards are supplied by customer.

**30' Semi-Gable Greenhouse Frame**

The Semi-Gable Greenhouse is designed as a multi-use greenhouse for hanging baskets, flowers and nursery stock.

- Mechanical galvanized carbon steel pipe
- High rating 55,000 PSI
- Two-piece bows are secured with 1-5/8" sleeve
- Built-in 6 ft. sidewall
- 3 rows of 1-3/8" x 16 gauge purlins
- Legs are 2.19" x 16 or heavier gauge pipe



30' wide Semi-Gable available in 2-3/8" diameter bows with 2-7/8" legs.

**To Cover a 30' wide Semi-Gable Greenhouse**

- 48' wide poly covers ground to ground
- 44' wide shade cloth covers ground to ground
- 40' wide shade cloth or poly covers this house if attached at the 4' side boards.

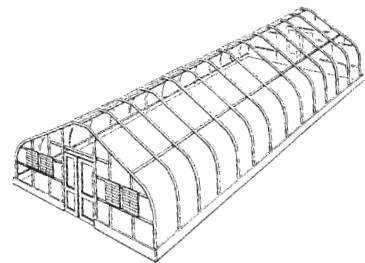
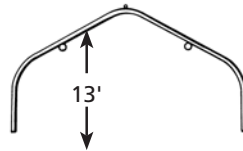

*Greenhouses manufactured by OBC Northwest are non-coded structures and OBC does not express or imply that they meet any Uniform Building Codes*

**Oregon Contractors No. 127055  
Washington Contractors No. OBCN01\*022CR**

# Customized To Your Needs!

## Low Profile 20' wide Semi-Quonset Greenhouse Frame



Commonly used as a propagation house.

- 1-3/8" & 1-5/8" steel pipe
- legs are 1-5/8"
- 1 run of 1-3/8" purlin
- mechanical galvanized carbon steel pipe

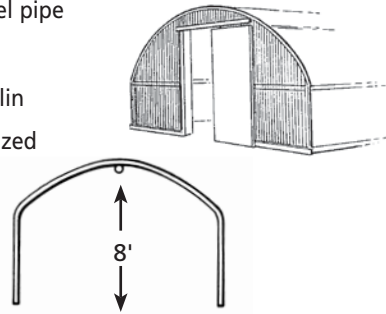

### To cover a 20' wide Low Profile Semi-Quonset Greenhouse

- 32' wide poly covers house ground to ground
- 30' wide shade cloth covers ground to ground
- 24' wide shade cloth or poly covers this type house when attached at the 4' side boards

### 14' - 15' QUONSET

- 1-3-8" 16 Ga. and 1-5/8" 15 Ga. bows spaced 4', 5' or 6' o/c
- 1-5/8" or 1-7/8" 15 Ga. legs
- One run 1-3/8" purlin and four corner wind braces.
- 28' wide poly covers this house ground to ground allowing for inflation.
- 24' wide shade cloth taped and grommetted covers ground to ground over singler layer poly.
- 26' wide shade cloth covers inflated poly mounted ground to ground.

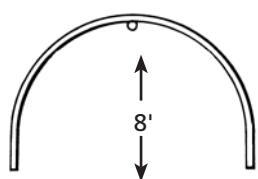

## Wintering Over Greenhouse 15' or 30' wide Quonset House Frame



### 30' QUONSET

- 1-7/8" 15 Ga. or 13 Ga. bows spaced 4', 5' or 6' o/c
- 2.197 16 Ga. or 13 Ga. legs
- Three runs of 1-3/8" purlin and 4 corner wind braces.
- 48' wide poly covers this frame ground to ground.
- 44' shade covers inflated poly ground to ground.

**Greenhouses manufactured by OBC Northwest are non-coded structures and OBC does not express or imply that they meet any Uniform Building Codes**

**Oregon Contractors No. 127055  
Washington Contractors No. OBCNO1\*022CR**

# Conley's Manufacturing and Sales

Conley has devoted over 50 years of service to the nursery industry with the development and implementation of quality greenhouse products. Over the years, the Conley name has become synonymous with reliability and value. Long considered a leader in technological innovations, Conley incorporates only state-of-the-art designs, materials and manufacturing techniques in its production of greenhouse structures and related products.

Here are some of the innovations incorporated into the Conley line:

- Superior strength rollformed technology
- Patented condensate removal system
- Cantilevered gutters

**Styles available to fit every installation!**

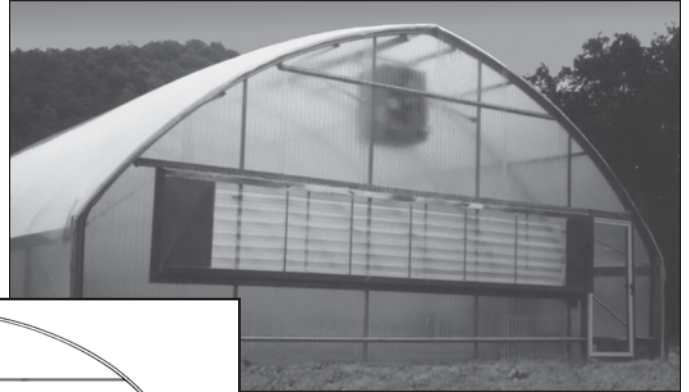

## Ranger Series 2000

Equally at home as a growing area or sophisticated retail center. The Series 2000 is designed for poly, shade or rigid coverings. Engineering available to customer's requirements.

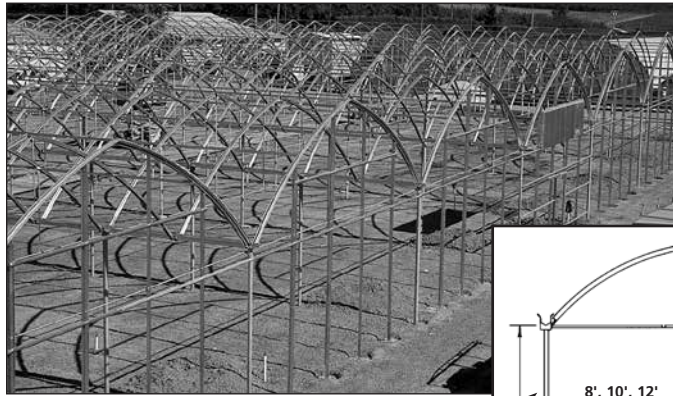
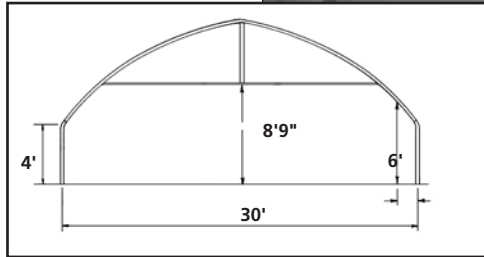

## Super Star Series 3600

The best value for the dollar, Conley's Series 3600 is designed for poly roof coverings and poly, shade or rigid side and end wall coverings. Available with a 10 pound to 30 pound live load and up to 110 MPH wind loads.

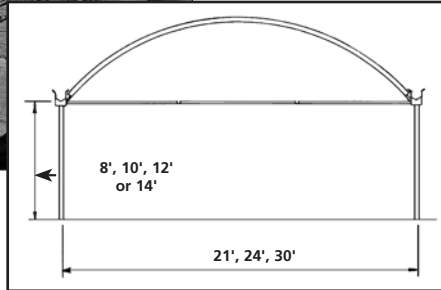

**OBC Northwest offers a full range of Greenhouse Construction Services**

## Arch Series 6500

An industry tradition, the Series 6500 Gothic Arch design is functional at both shedding snow and combatting overhead drip. This structure can be glazed in poly or rigid coverings. Available in 10 pound, 20 pound or 30 pound snow load.

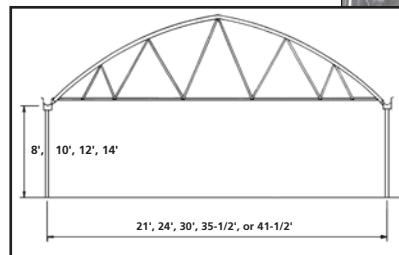
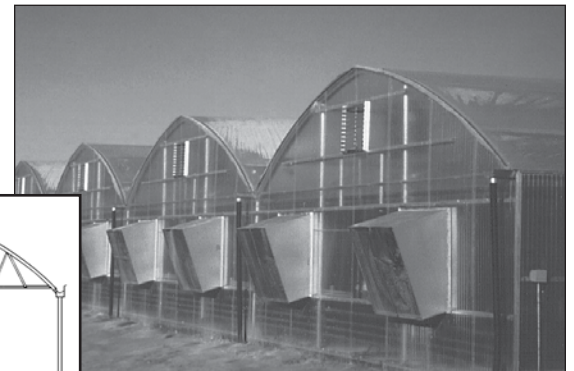

**Oregon Contractors  
No. 127055**  
**Washington Contractors  
No. OBCNO1\*022CR**



## Gable Series 7500

The versatility of the Series 7500 makes it ideal for applications ranging from growing to retail or even metal covered houses. This structure is designed to be glazed in poly or rigid coverings. Available in 10 pound, 20 pound or 30 pound snow load.

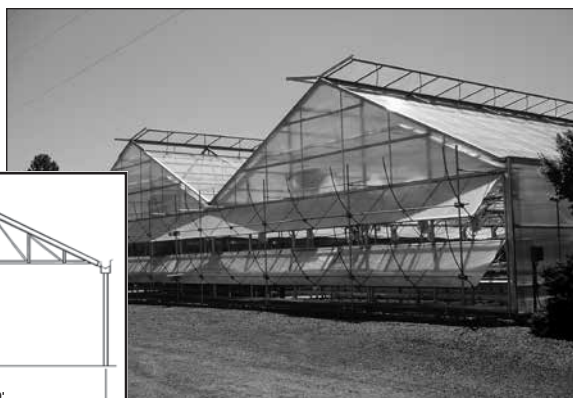
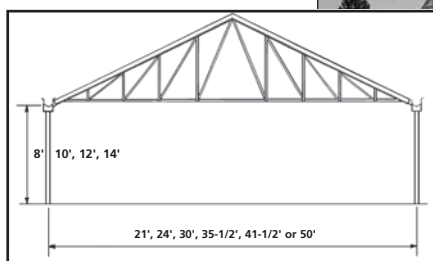

## Over-Easy Rolling Bench

- Will not tip even if cantilever is fully loaded.
- All parts are pre-punched and pre-formed galvanized steel.
- Conley's Anti-Tip brackets are anchored on both sides of cross bar assemblies.
- Bench top frame is one-piece and has no upper lip to catch pots or plants.
- Stiffener channels in Conley's Anti-Tip bracket minimizes drag on roll bar.
- Conley's peaked roll bar is designed to roll easier and avoids potting soil build-up.

Choose from a variety of widths: 5', 5'6", 6', and 6'6".  
Length ordered in 2' increments.



## Stand-Firm Bench

Conley's Stand-Firm Bench is made from the same fine quality materials as the Over-Easy Rolling Bench. It is made to anchor to a cement floor or set in a concrete filled footing. Choose from a variety of widths: 3', 4', 5', 5'6", 6', and 6'6". Length ordered in 2' increments.

Both the Over-Easy bench and the Stand-Firm bench are made for three types of bench top materials: **Expanded Metal**, **Easy-Grow Bench Top** or **Shepherd Bench Wire**

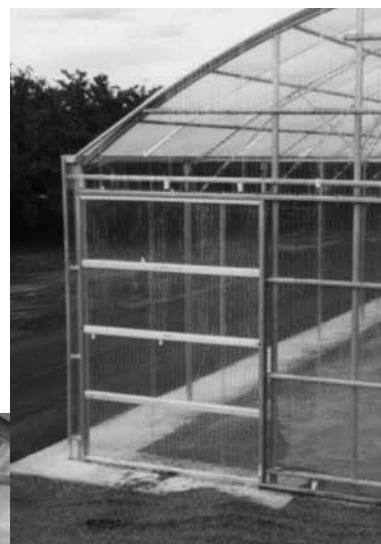

## Conley Sliding and Swing Doors

All doors come complete with tracks, frame jambs, flashing and hardware. Covering options: fiberglass, metal or polycarbonate.

### A Variety of Doors Are Available:

- Swing Doors
- Single Sliding Doors
- Double Sliding Doors
- Roll-up Doors





## Micro-Grow Growlink

### A Windows® PC Operational System for Today's Growers

Couple your Growmaster and Weathermaster computer control systems with the Growlink program to open up an entire world of communications and reporting functions for your greenhouse range.

- Easy to Use PC Program.
- Operates with Microsoft Windows.
- Generates Graphs and Reports.
- Remote Monitoring and Control.
- Modem Accessible.



## Micro-Grow Growstat

### Computer Based Accurate Controls

Computer accuracy at an attractive price easy-to-use front panel programming. Large and convenient digital display.

#### GROWSTAT Control

Two stages of heating, cooling, or a combination of both. Complete with one temperature sensor and an internal photocell for night detection.



#### VENTSTAT Control

Operates roof or side vents. Also operates roll up curtains and retractable roofs in up to eight stages each, without using inter-stage mercury or position switches.

#### SHADESTAT Control

Monitors solar intensity and will pull a shade system in up to eight stages as the solar level increases. Includes an energy curtain feature for night heating. For new or existing shade systems.



## Micro-Grow Water Plus

### Misting and Irrigation Control System

Vapor Pressure Deficit (VPD) technology is designed to deliver the exact amount of water that the plant needs based on the ever changing environmental conditions of the crop, and the simulated leaf temperature of the plant. Any combination of misting or irrigation stations may be used. Excellent for use with hydroponic watering applications.

## Micro-Grow Ventmate

Pulses two sets of vents. Two stages of heating. From MICRO-GROW Greenhouse Systems, Inc.

# Delta-T Hot Water Heating Systems

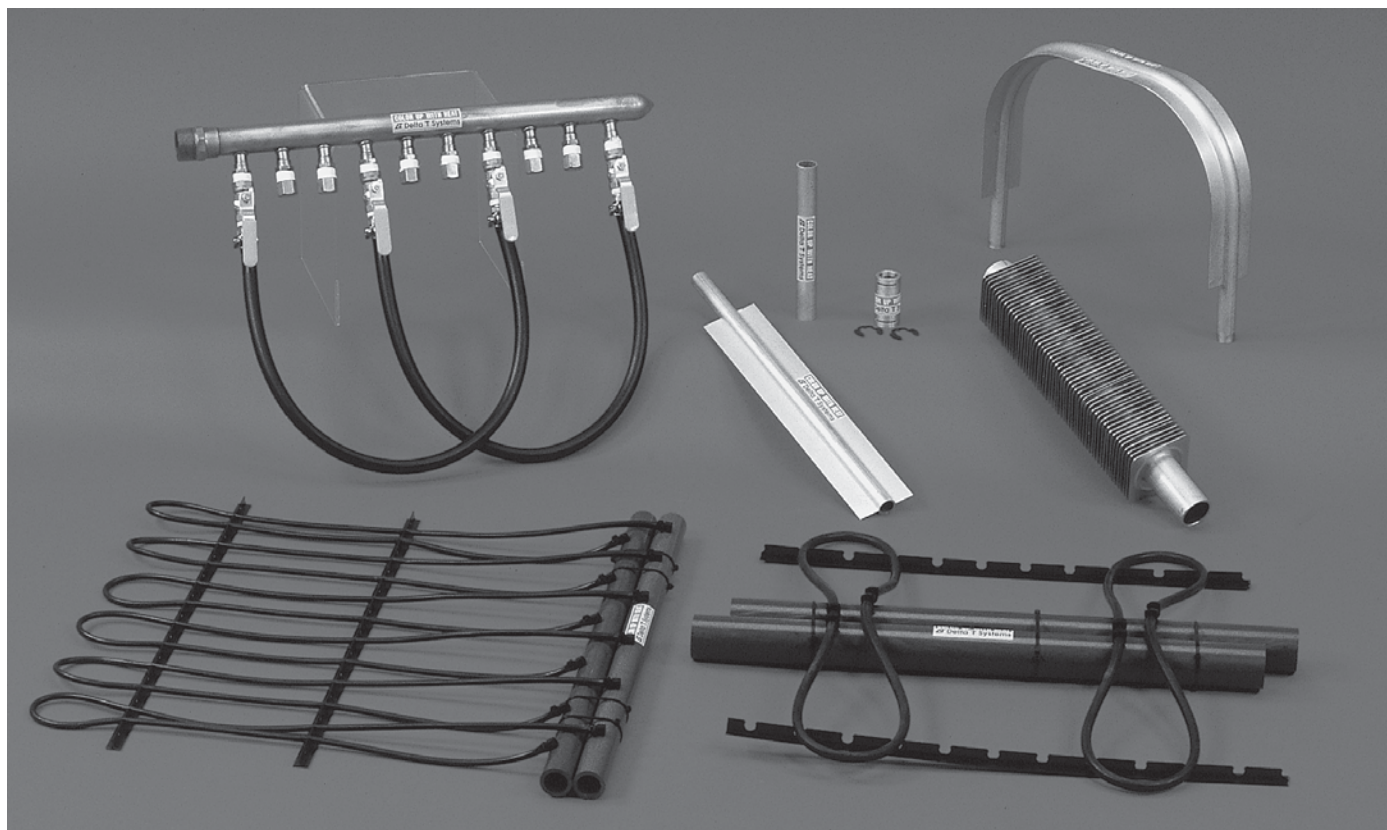

Delta-T Systems offers an array of hot water heating systems for virtually all types of growing needs.

## Delta T Solutions

### Delta Tube™ Small Diameter EPDM Rubber Tube Bench Top Heating System

Here's why this system is the grower's choice: This system provides the best growing environment for propagators, plug producers and general growers. It helps to produce healthy, more uniform plants while providing you with fuel savings of at least 20%!

### Delta Tube™ Large Diameter EPDM Rubber Tube In-Ground Heating System

Ideal for larger ranges, this system excels in the nursery industry. It is very economical for starter houses and will also save you 20% or more over conventional forced-air heating units.

### Delta-T Gas Fired Hot Water Boiler

The Delta T Boiler is specifically designed for today's greenhouse heating system with versatility, reliability, efficiency, and ease of service in mind. The advanced controls and sizes up to 4,000,000 BTUH, are designed to be used with environmental computer controls. The boilers are immune to thermal shock up to 150 degrees temperature difference.

Available in 26 different model sizes, Delta T boilers are all energy efficient (AGA certified 82%) and conform to government emission standards.

### Delta-Fin™ SP High Output Finned Pipe

The Delta-Fin™ aluminum finned pipe heating system heats the greenhouse using water temperatures up to 230 degrees by heating the air around the fin tube and distributing heat through natural convection.

Placed around the perimeter or under the gutter, this material puts out enough heat to heat a greenhouse range, melt the snow from the gutter, or can be used as supplemental heat when an under bench system is being used.

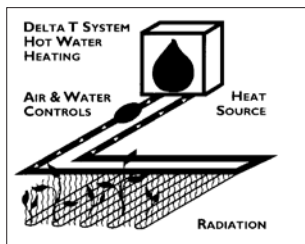

Other types of hot water heating systems are available.

## Polyethylene Convection Tube

Used in conjunction with Coolair Power Tube Fans

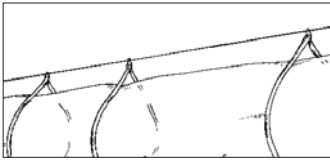

This 4 mil polyethylene tube is protected by a strong, untinted ultra-violet inhibitor. The plastic also has an additive to increase its strength and light penetration. Equivalent

strength of a 5-1/2 mil tube. Manufactured using a formulation specified for greenhouse environments and fully guaranteed for one year. Each tube is custom punched with proper diameter holes and spacing.

### Punch Positions available:

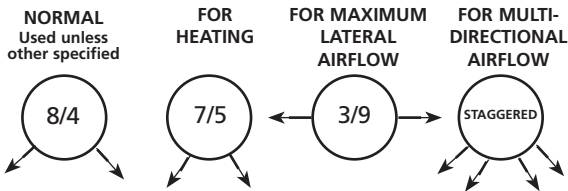

## Shutters

Prod. Code **GSACLRW**

Extruded aluminum frame shutter with interlocking aluminum blades for maximum weather seal. Available as gravity or motor operated.

## Poly Tube Hangers

Made of a durable UV resistant polypropylene webbing. Brass grommet eyelets with hooks. Custom sizes available.



Prod. Code	Tube Size	Hanger Length
<b>GSCH06</b>	<b>18"</b>	<b>6'</b>
<b>GSCH07</b>	<b>24"</b>	<b>7'</b>
<b>GSCH08</b>	<b>30"</b>	<b>8'</b>

## Exhaust Fans

Prod. Code **GSACNBF**

Today's best investment. The NBF type fan uses the most efficient ball-bearing motors available. They are totally enclosed, resilient based.

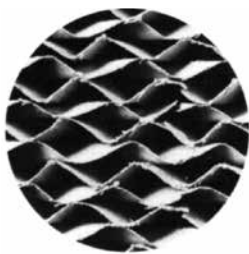

## Cooling Pad

Prod. Code **GSACGCP**

Counter periods of extreme temperature that affect in-house environments and production. Used in conjunction with Coolair fan applications. Temperature reductions of 10° to 25° degrees.



## 2-Stage Thermostat

Prod. Code **GSACT109**

2-stage, single pole.  
1 HP capacity, 40-100 degrees.



## Power Tube Fan

Prod. Code **GSACPTF**

Specially designed units developed for compatibility with polyethylene tubes. Use in controlled environments where precise tempering of air is critical to production. Perfectly matched for low-velocity tempering of air. Available in 12" to 30" fans.



## Tubular Gas-Fired Unit Heaters

Use outside air for combustion, enabling operation in areas having slight negative pressures (near exhaust fans, etc.) with no adverse effect upon combustion or venting. Special environments can be effectively heated since these burners isolate the burner from dust, humidity and non-hazardous chemicals. Uses a 24V thermostat, not included. For application in altitudes above 2,000 ft., the burner orifices need to be derated. Flue not included.

Available in aluminized or stainless steel. Comes with a 10 year heat exchanger warranty. Available in natural gas or propane, in 30,000-40,000 BTU's. Please call for more details.

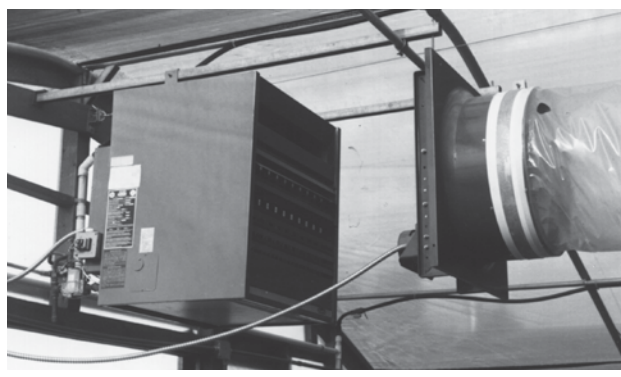

## Aluminum Extrusions

24' Universal Vent Seal

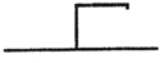

GSEXA9970015

24' Gable End Bar

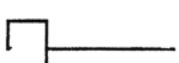

GSEXA9970250

Twinwall Glazing Bar Cap

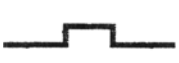

GSEXA0070355

Twinwall Glazing Bar



GSEXA9970350

## Conley Roll Form

GHCG0000312



## Aluminum Lathe

GSEXALL

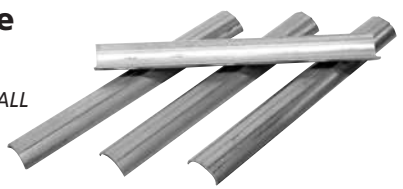

## Heater Hangers

In Line Heater Hanger

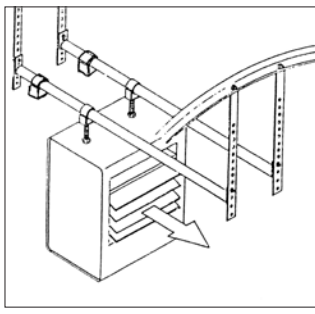

GHCH003000

Side Mount Heater Hanger

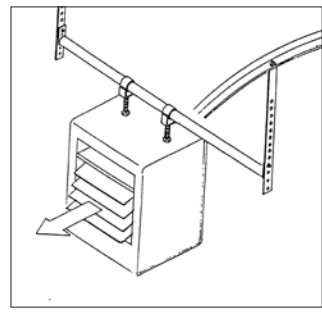

GHCH0094000

Not to be used in 15' or 20' wide frames.

## Spring Lock

Very useful for holding poly and shade cloth materials. You can put one spring in to hold poly, then apply shade cloth with an additional spring. Sold in 6' lengths. Spring is sold separately.

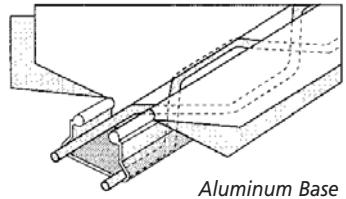

Aluminum Base  
Stainless Steel Spring

Prod. Code	Product	Wt. Lbs.
GSSLB06	spring lock base	1.08
GSSLS06	spring lock spring	.15

## Cross Connectors

GH138CC, GH 158CC, GH2CC

## Endwall Tabs

GHCT0030880, GHCT00380890

## Pipe Straps

GH1PS, GH114PS, GH112PS, GH2PS

## Brace Bands

GH138BB, GH158BB, GH178BB

## Spacer Washers

GHCV9970300

## Neoprene Washers

## Lap Fasteners

## Caulking

## OBC Swing Doors

## OBC Sliding Doors

## Pop Rivets

GHBRW

## #14 Wood Screws

GH14WS

## #12 Tek Screws w/ neo washers

GH12TSW

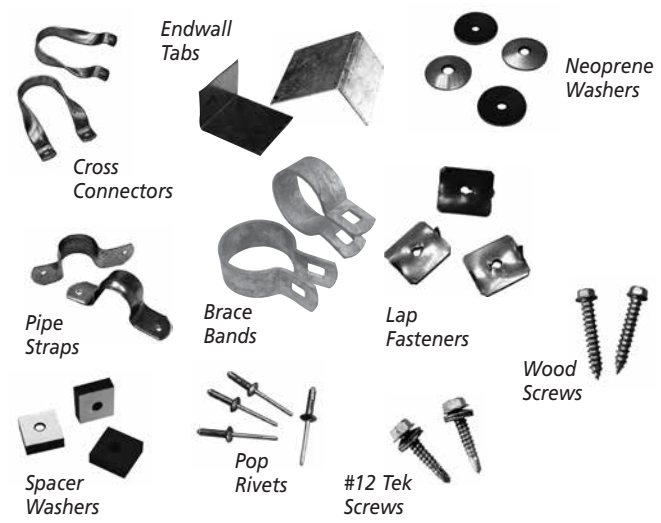



## Horizontal Air-Flow Fans Greenhouse Air Circulator

- Fan holes are larger than traditional basket fans & provide double the circulation of traditional models
- Heavy-duty bearing motors are maintenance-free & highly energy efficient
- Noise levels are low – well below OSHA noise level requirements for plant environments
- The fan mounts closer to the ceiling trusses for more head room clearance

Prod Code	Size	Wt. Lb.	CFM	HP	Volts	Amps
GSSVS08VK	8"	8	466	1/100	115	.6
GSSVS12	12"	18	1554	1/10	115/230	.9/1.45
GSSVS20	20"	38	5516	1/3	115/230	3.8/1.9
GSSVS24	24"	46	7784	1/2	115/230	5/2.5



## Mist Kits

This mist kit can cool temperatures up to 20°F using 1/2 gallon of water per hour at 40 PSI. Adjustable nozzles have a stainless steel orifice and pin and includes an O-ring for leak proof assembly. For use on circulation fans.

- GSSMK1200** Mist Kits - 12" horizontal air flow fans
- GSSMK100** Mist Kits - 20" and 24" fans

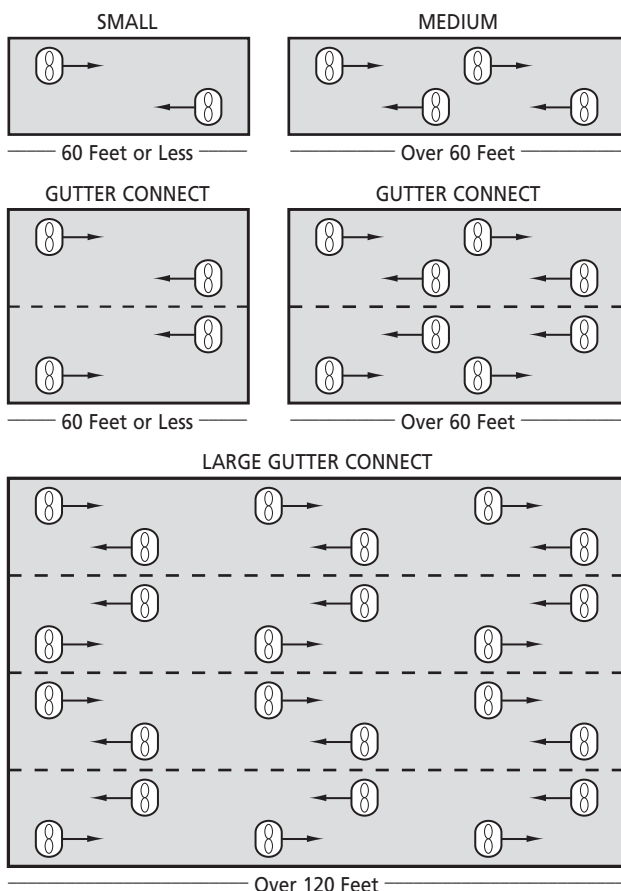

## Temperature & Ventilation Control

Honeywell hydraulic capillary sensor. Slotted case protects coiled copper tube sensing element while allowing maximum air circulation. Snap switches permanently sealed against corrosion. UL recognized, CSA certified.



Prod Code	Wt. Lb.	Temp. Range
GSST335	1	40-105 degrees F

## 2-Speed Thermostat

Prod Code	Wt. Lb.	Temp. Range
GSACT109	1	40-100 degrees F

## Premium Greenhouse Shading Compound

A gallon of concentrate, mixed with water should cover approx. 2,000 sq. ft. of area.

Developed by greenhouse growers with one goal in mind: to produce the finest shading compound on the market and offer it at a fair price. It effectively reflects the rays of the sun. It will enable the grower to control light intensity and reduce heat build-up in the greenhouse environment. It is usually used at a rate of 1 part shading compound to 8 parts water.

### Available in two formulations:

#### Light stick (Prod. Code: GSSHADELTSTICK5)

- Perfect for seasonal or temporary shading
- Formulated with very little binding agent
- Majority removed with moderate rain
- Easy 100% removal with light brushing

#### Regular stick (Prod. Code: GSSHADEREGSTICK5)

- Perfect for year-round shading
- Formulated with medium binding agent
- Some shading removed with heavy rain
- Most shading removable with moderate brushing
- Holds up to coastal fog and drizzle

Size	Wt. Lb.
5 gallons	65

## Antidrip Compound



Sun Clear® is supplied as a concentrated liquid. It works well on polyethylene, vinyl film plastics and rigid materials such as fiberglass and polycarbonate to stop condensation and increase light transmission. Sun Clear® coated plastic will transmit up to 50% more light than dripping, uncoated plastic.

Prod. Code	Case Quantity	Wt. Lb.
GSSCG	Gallon 4	9.5

## Dura-Bench Bench Top

### GSBEZG

Overlapping style recommended for permanent, continuous benches. Used in wood frame bench construction or metal benches such as Conley's Over-Easy and Stand-Firm benches.

#### Features:

- Slats interlock on the 4' sides for easy assembly and strength.
- Slats can be cut to fit any dimension.
- In addition to end supports, slats must be supported.
- Panel sizes available: 2' wide x 4' long, 1" square mesh.

Wt/Lb 6

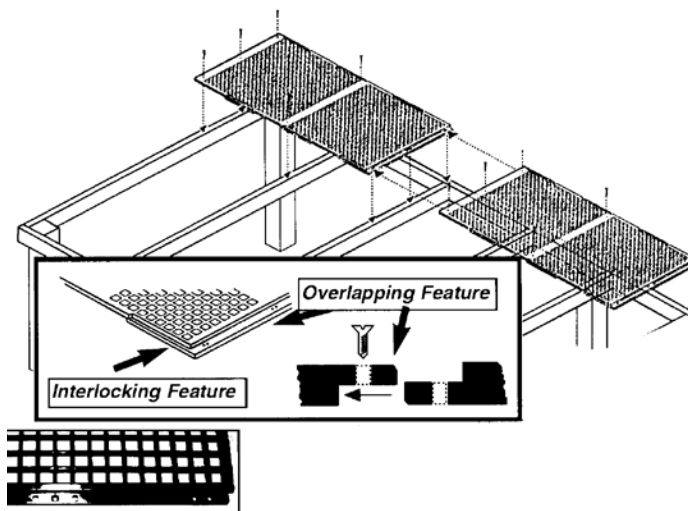

## Expanded Metal Bench Top

### GSBXM68

- 3/4", 13 gauge panels. Hot-dipped galvanized after cut.
- A heavy-duty uni-shear recommended to cut panels to size; they can be obtained from rental yard.
- Panel sizes available: 6' wide x 8' long
- Custom sizes, special order.

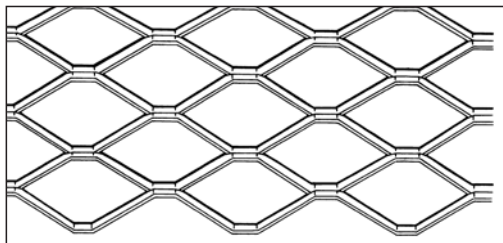

## Poly Repair Tape

UV stabilized, 7.5 mil polyethylene tape lasts up to two years.

Prod. Code	Wt. Lbs.	Size
PFPRT02	.625	2" x 108'
PFPRT04	1.5	4" x 108'
PFPRT06	2	6" x 108'
PFPRT10	3.5	10" x 108'

## Binding Tape Tie Down

UV stabilized, polypropylene webbing. Tie down can be used over the top of your greenhouse poly, in between the greenhouse bow frames. Extra protection against heavy winds. Will not rub or wear poly film.

Prod. Code	Wt. Lbs.	Roll Size
SCBT234300	2.5	2-3/4" x 300'

## Batten Tape

White vinyl strip, 3/4" wide x 1/32" thick, formulated to resist UV radiation and extreme cold.

Prod. Code	Wt. Lbs.	Roll Size	Color
GSBT	7.5	3/4" x 500'	White

Visit our comprehensive website, now including pricing and more products.

Easy ordering for your convenience, 24 hours a day.

Go to [www.obcnw.com](http://www.obcnw.com) and place your order now!

## Mounting Bracket

Dutch Fork has designed an effective bracket to stabilize and hold greenhouse inflation blowers.



Prod. Code	Product	Wt. Lbs.
<b>GSLBLB</b> (use w/ GSG2C647)	<b>inflation fan mounting bracket</b>	<b>1</b>
<b>GSBLSBK</b> (use w/ GSSB148)	<b>square blower bracket kit</b>	<b>1</b>

## Outside Air Inflation Kit

**GSOAIK** – Contains a new blower that uses a permanent split capacitor motor requiring less energy to keep a greenhouse inflated.

**Kit contains:**

- Inflation Blower
- Mounting Bracket with Air Deflector
- Outside Air Regulator
- 6' Jumper Hose

## Outside Air Inlet/ Retro Fit Kit

**GSBLRFK** – 72" corrugated air inlet hose attaches to the blower. This kit brings cooler outside air into the center layers of the inflated plastic.

Prod. Code	Wt. lbs.
<b>GSBLRFK</b>	<b>1.35</b>

## Zip Up™ Peel & Stick Greenhouse Zipper

The original "peel & stick" access to greenhouse coverings. Cut with a razor knife to create access. Two units spaced apart will create an opening that can be rolled up. Color: White



Prod. Code	Wt. Oz.	Size
<b>GSZ63WH</b>	<b>2</b>	<b>6'x3"</b>
<b>GSZ73WH</b>	<b>3</b>	<b>7'x3"</b>

## Jumper Hose

24" black corrugated hose with simple twist-on fittings.



Prod. Code	Wt. lbs.
<b>GSJK24</b>	<b>.15</b>

## Inflation Blower

Rated for continuous duty with adjustable air inlet dampener. Maximum ambient temperature 104° F. 3 5-55 CFM **Model # 4C440**



Prod. Code	Wt. Lbs.	Volts	Amps	HP
<b>GSIB60</b>	<b>3.75</b>	<b>115</b>	<b>.49/42</b>	<b>1/125</b>

## Heavy Duty Inflation Blower

Requires a special bracket.

Prod. Code	Wt. Lbs.
<b>GSSB148</b> (use with GSBLSBK)	<b>5</b>



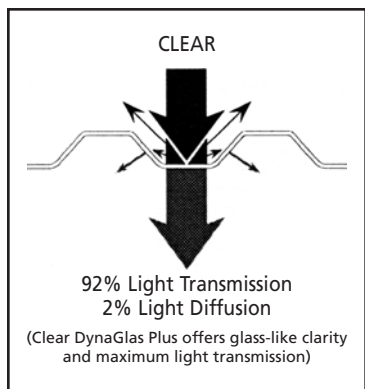

## Polycarbonate Plus Greca

DynaGlas Plus corrugated panels come with a warranted anti-condensate control and UV protection on one side. DynaGlas offers the same sparkling clarity as glass, but transmits as much as 7% more light. These panels are exceptionally resistant to weathering. Co-extruded UV protection ensures against loss of light transmission due to yellowing. DynaGlas Plus is lightweight and flexible yet it is virtually unbreakable.

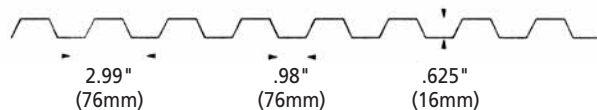

**Full Lengths: Clear = 32' / Opal = 32' – OBC will cut shorter lengths from full lengths.**

**Prod. Code GSDG4133\_**

**Structure Type: Greca**

Overall Width .....	49.6"	Depth .....	0.625"	Coefficient of Thermal Expansion.....	3.6 x 10-5 in/in/°F
Overall Length.....	up to 32'	Thickness.....	0.03"	UV Transmission .....	<1%
Net Coverage.....	47.8"	Light (Clear).....	92%	Min. Bending Radius (ft. /1 in ).....	16'
Pitch .....	2.99"	Transmission (Gray).....	35%	R / U Factor .....	R=0.83 / U=1.20
		ASTM-D1003 (Opal) .....	45%		

## Polycarbonate 8mm Twin-Wall



ThermaGlas® Twin-Wall polycarbonate provides clarity, durability and strength. Because the panels have an insulating air-filled space between the inner and outer wall, energy efficiency is increased. While 4mm, 6mm, 8mm, 10mm and 16mm thicknesses are available, 8mm is the industry-standard thickness for most double layer polycarbonate products in the commercial greenhouse market. This is because it offers the best combination of strength, rigidity, good insulation value and cost, as well as a wide variety of attractively priced glazing systems.

**Full Lengths: Clear = 32'**  
**OBC will cut shorter lengths from full lengths.**

**Prod. Code GSTG7125\_**

**Structure Type: 8mm Double Wall**

Overall Width .....	71.25"
Overall Length.....	up to 24'
Pitch .....	N/A
Depth .....	N/A
Thickness.....	5/16"
Light (Clear).....	80%
Transmission (Bronze).....	35%
ASTM-D1003 (Opal) .....	45%
Coefficient of Linear Thermal Expansion.....	3.6 x 10-5 in/in/°F
UV Transmission .....	0.5%
Minimum Bending Radius .....	4.59'
U-Value BTU/hr.- ft. 2 F .....	0.58
R-Factor.....	1.72



GSCXCSRR



GSCXCSV

## Closure Strips for Polycarbonete Sheetting

Made of foam rubber. 100 per box. Sold per each.

Prod. Code	Description
GSCXCSRR	Corrugated, 1" x 3'
GSCXCSV	Vertical, 1" x 3'
GSCXCSDW	DBL Wall 1" x 3/4" x 3'



# TUFFLITE™

## Tufflite™ IV Film

Prod. Code	6 Mil Roll Size	Net Wt.	Prod. Code	6 Mil Roll Size	Net Wt.	Prod. Code	6 Mil Roll Size	Net Wt.
PFT4101006	10' x 100'	39	PFT4281506	28' x 150'	148	PFT44402506	40' x 250'	300
PFT4141006	14' x 100'	52	***PFT4321006	32' x 100'	96	PFT4403006	40' x 300'	360
PFT4161006	16' x 100'	59	PFT4321106	32' x 110'	105.6	PFT4421006	42' x 100'	126
PFT4201006	20' x 100'	60	PFT4321256	32' x 125'	120	PFT4421506	42' x 150'	189
PFT4201106	20' x 110'	66	***PFT4321506	32' x 150'	144	PFT4481006	48' x 100'	144
PFT4201506	20' x 150'	90	PFT4361106	36' x 110'	118.8	PFT4481506	48' x 150'	216
***PFT4241006	24' x 100'	72	PFT4361506	36' x 150'	162	PFT4501006	50' x 100'	150
PFT4241106	24' x 110'	79.2	***PFT4401006	40' x 100'	120	PFT4501506	50' x 150'	252
PFT4241256	24' x 125'	90	PFT4401106	40' x 110'	132	PFT4561006	56' x 100'	168
***PFT4241506	24' x 150'	108	PFT4401256	40' x 125'	150	PFT4561506	56' x 150'	252
PFT4281006	28' x 100'	102	***PFT4401506	40' x 150'	180			
PFT4281106	28' x 110'	92.4	PFT4402006	40' x 200'	240			

56' is widest T4 that can be ordered  
\*\*\*Also available in white

## Nursery Clear 4 4 mil with some UV stabilizers. 1-year warranty.

Prod. Code	Roll Size	Net Wt.	Prod. Code	Roll Size	Net Wt.	Prod. Code	Roll Size	Net Wt.
PFNC82204	8' x 220'	35.2	PFNC162204	16' x 220'	70.4	PFNC282204	28' x 220'	123.2
PFNC101004	10' x 100'	20	PFNC182204	18' x 220'	79.2	PFNC321004	32' x 100'	64
PFNC102204	10' x 220'	44	PFNC201004	20' x 100'	40	PFNC321504	32' x 150'	96
PFNC121004	12' x 100'	24	PFNC201504	20' x 150'	60	PFNC401004	40' x 100'	80
PFNC122204	12' x 220'	52.8	PFNC241004	24' x 100'	48	PFNC401504	40' x 150'	120
PFNC124404	12' x 440'	105.6	PFNC241504	24' x 150'	72	**PFNC421004	42' x 100'	84
PFNC142204	14' x 220'	61.6	PFNC281004	28' x 100'	56	PFNC481004	48' x 100'	96
PFNC144404	14' x 440'	123.2	PFNC281504	28' x 150'	84			

\*\*NON STOCK ITEM, ALLOW FOR LEAD TIME

## Nursery Clear 6 6 mil with some UV stabilizers. 1-year warranty.

Prod. Code	Roll Size	Net Wt.	Prod. Code	Roll Size	Net Wt.	Prod. Code	Roll Size	Net Wt.
PFNC101006	10' x 100'	30	PFNC281006	28' x 100'	84	PFNC421006	42' x 100'	126
PFNC121006	12' x 100'	36	PFNC281506	28' x 150'	126	**PFNC481006	48' x 100'	144
PFNC201006	20' x 100'	60	PFNC321006	32' x 100'	96	PFNC481506	48' x 150'	216
PFNC201506	20' x 150'	90	PFNC321506	32' x 150'	144	PFNC501006	50' x 100'	150
PFNC241006	24' x 100'	72	PFNC401006	40' x 100'	120			
PFNC241506	24' x 150'	108	PFNC401506	40' x 150'	180			

\*\*NON STOCK ITEM, ALLOW FOR LEAD TIME

## Co-Poly Overwintering Film

Prod. Code	4/6 Mil Roll Size	Net Wt.	Prod. Code	4/6 Mil Roll Size	Net Wt.	Prod. Code	4/6 Mil Roll Size	Net Wt.
PFCW101104	10' x 110'	22	PFCW242004	24' x 200'	96	PFCW321504	32' x 150'	96
PFCW121104	12' x 110'	26.4	PFCW242204	24' x 220'	105.6	PFCW322254	32' x 225'	144
PFCW241004	24' x 100'	48	PFCW281104	28' x 110'	61.6	PFCW401004	40' x 100'	77.0
PFCW241104	24' x 110'	52.8	PFCW281254	28' x 125'	70	PFCW401106	40' x 110'	127.0
PFCW241106	24' x 110'	79.2	PFCW321004	32' x 100'	64	PFCW401254	40' x 125'	100
PFCW241524	24' x 125'	60	PFCW321104	32' x 110'	70.4	PFCW401256	40' x 125'	150
PFCW241256	24' x 125'	90	PFCW321106	32' x 110'	118.4	PFCW401504	40' x 150'	120
PFCW241504	24' x 150'	72	PFCW321254	32' x 125'	80			

The AgroFabric® System provides essential frost and freeze protection for vegetables, foliage, nursery stock, citrus, strawberries, containerized ornamentals and turf. There's an AgroFabric cover for just about any crop or weather condition – they're ideal tools for overwintering, wind break and overall yield enhancement.

## PRO17

**+2° TO 4°F**  
.5 OZ. PER SQ. YD.  
LIGHTWEIGHT

## PRO50

**+6° TO 8°F**  
1.5 OZ. PER SQ. YD.

## PRO34

**+4° TO 6°F**  
1.0 OZ. PER SQ. YD.

## PRO70

**8°+ F**  
2 OZ. PER SQ. YD.



### Specifications:

Elongation MD .....	50
Basis Weight .....	17 GSM
Elongation CD .....	60
Tensile Strength MD .....	42
Air Permeability (cfm).....	650
Tensile Strength CD.....	22
Impact Resistance.....	50

## PRO17

Our most popular weight fabric offers excellent flexibility as an emergency frost protector as well as an integral management tool for growers looking to encourage earliness and extend harvest windows. Pro 17 is a 17g/sm or .5 oz/sq yd material that allows for approximately 85% light transmission. Pro 17 will raise minimum temperatures by as much as 4°F. Folded for UPS. Other sizes available.

Prod. Code	Description	Wt. Lbs.
MSCCPRO176225	6' x 225' Crop Cover	7
MSCCPRO176250	6' x 250' Crop Cover	7
MSCCPRO1762550	6' x 2550' Crop Cover	54
MSCCPRO177250	7' x 250' Crop Cover	8
MSCCPRO1707500	7' x 500' Crop Cover	13
MSCCPRO1713300	13' x 300' Crop Cover	14
MSCCPRO1713500	13' x 500' Crop Cover	23
MSCCPRO17131000	13' x 1000' Crop Cover	46
MSCCPRO17301000	30' x 1000' Crop Cover	105

## PRO19

Prod. Code	Description	Wt. Lbs.
MSCCPRO1962500	6' x 2500' Crop Cover	57
MSCCPRO1913300	13' x 300' Crop Cover	15

## PRO34

Prod. Code	Description	Wt. Lbs.
MSCCPRO346250	6' x 250' Crop Cover	12
MSCCPRO3410300	10' x 300' Crop Cover	63
MSCCPRO3413250	13' x 250' Crop Cover	24
MSCCPRO34131000	13' x 1000' Crop Cover	91
MSCCPRO3426500	26' x 500' Crop Cover	91
MSCCPRO34261000	26' x 1000' Crop Cover	181

## PRO50

Prod. Code	Description	Wt. Lbs.
MSCCPRO506250	6' x 250' Crop Cover	16
MSCCPRO5010300	10' x 300' Crop Cover	31
MSCCPRO5013500	13' x 500' Crop Cover	68
MSCCPRO5015500	15' x 500' Crop Cover	78
MSCCPRO5026500	26' x 500' Crop Cover	136
MSCCPRO50261000	26' x 1000' Crop Cover	271
MSCCPRO5039250	39' x 250' Crop Cover	102

## PRO70

Prod. Code	Description	Wt. Lbs.
MSCCPRO7013300	13' x 300' Crop Cover	54
MSCCPRO7013500	13' x 500' Crop Cover	91
MSCCPRO7015300	15' x 300' Crop Cover	63
MSCCPRO7026300	26' x 300' Crop Cover	109

## Jute Erosion Netting

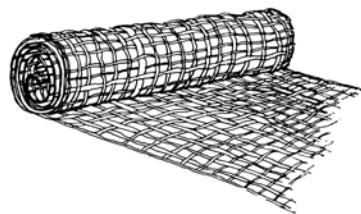

Uses/features:

- Erosion control problems
- Landfill slopes
- Highway construction
- Landscape projects
- Sod stabilization
- Reclaiming wetland areas
- All natural bio-degradable material
- Best results when anchored with staples

Prod. Code	Size: Width/Length	Wt. Lbs.
MSNE	1/2" mesh 4'x 75 yards	102

## Erosion Net Staples

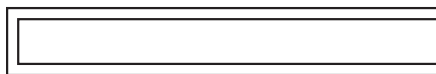

Prod. Code	Size: Width/Length	Shape	Wt. Lbs./100	Qty. Per Case
MSNS	1" x 6"	Square Top	3	1000
MSNS8	1" x 8"	Square Top	8	500

## Ground Cover Cloth



A tough versatile fabric designed to last years. Woven to keep weeds out and allow water to slowly disperse. Beware of light imitation film fabrics on the market. Look for Baycor ground cover cloth and you will be happy you switched from film to woven ground cover.

Prod. Code	Standard Roll Sizes: Width/Length	Wt. Lbs.
SCGC03300	3' x 300'	26
SCGC04300	4' x 300'	34
SCGC06300	6' x 300'	51
SCGC10300	10' x 300'	85
SCGC12300	12' x 300'	102
SCGC15300	15' x 300'	114

*Other sizes available, please call for details*

## Black Plastic Mulch

SRM Black plastic mulch for use with or without row covers. Black plastic has been used to suppress weed growth, reduce soil water loss, increase soil temperatures and improve vegetable yields.

**Specifications:** 1.0 mil, high density polyethylene.

Prod. Code	Size: Width/Length	Wt. Lbs.
MSCCM4600	4' x 500'	10
MSCCM44000	4' x 4000'	85

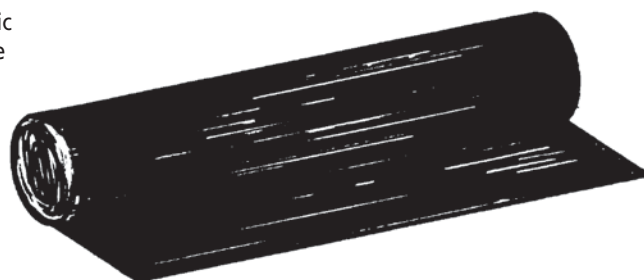

## SRM® Red Plastic Mulch

SRM Red plastic mulch is a recent innovation in an effort to maximize reflected light on plant growth. From many studies on the effect of mulch color on plant growth, red has been found to enhance the growth of several crops.

Features:

- Uniform red color for uniform field results
- Soil warming of 4 to 6 degrees F°
- Almost total weed control
- Reduction of soil moisture evaporation
- Soil nutrients are conserved, especially nitrogen
- Improved yields, although there will be variations year to year

Prod. Code	Size: Width/Length	Wt. Lbs.
MSCCMSRM4600	4' x 600'	15
MSCCMSRM43000	4' x 3000'	65



## Nico-Shade Fabric

Features:

- Woven polypropylene fabric
- Reinforced selvages for stronger edges
- Resists mildew and abrasion
- Resistant to most acids, alkalis and solvents
- Shade range: 47%, 55%, 63%, 73%, 80%
- Stock Widths: 6', 10', 12'. Can be converted up to 50'

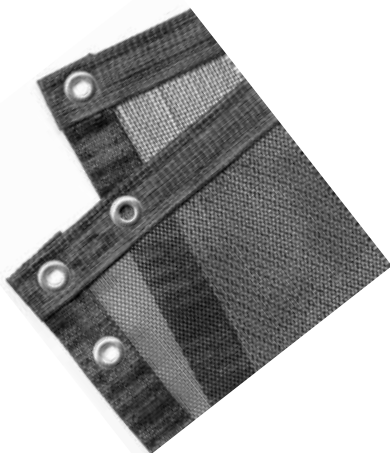

## Leno/Lock Shade Fabric

Features:

- 30% black
- Stock widths: 10' & 12'

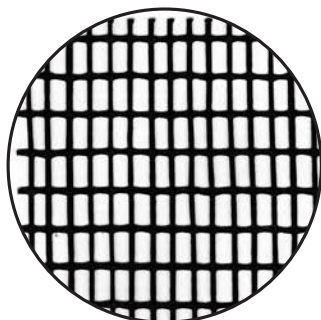

## Nico-Knit Fabric

Features:

- Knitted polypropylene fabric
- Good for use on truck tarps or heavy stress areas
- Resists tearing and puncturing
- Will not unravel
- Shade range: 40%, 50%, 60%, 70%

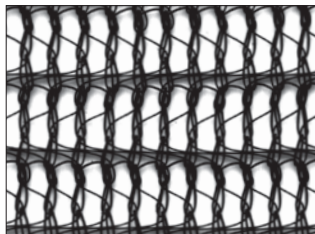

All shade fabric can be converted to your specifications at our factory.  
For more information call: 1-800-477-4744.

## Custom Fabric Conversions at OBC's Factory

**Guaranteed quality and service • Sizing • Taping • Grommets • Slitting • Special handling**

**Sizing:** We can seam Nico-Shade fabric together to make 16', 18', 20', 22', 24', 26', 28', 30', 32', 36', 38', and 40' wide without any upcharges. Pieces wider than 40' will be at an additional \$ .01 per square ft.

**Taping:** Used on edges for reinforcement, also used when grommets are installed.

**Grommets:** #2 grommet with a 3/8" opening.

**Slitting:** It is done when the width of the material needs to be cut down from our standard width.

**Special Handling:** We can customize special shapes per your drawing. We can upgrade or re-tape worn edges. We can also replace missing grommets on your shade cloth. With these services, you might be able to get a few more years out of the life of your material!

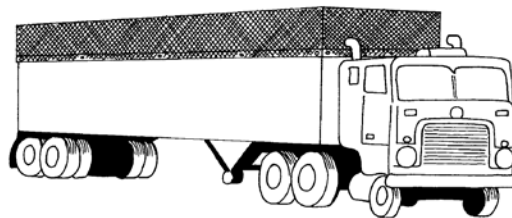

## Truck Tarps

Truck tarps fabricated to your size specifications with two rows of grommets. Second row of grommets added two feet from edge of tarp for flexibility. OBC Northwest recommends that truck tarps be made from 65% Green Lathe for extra durability and prolonged life of tarp.

## Insect Screen Fabric

### Bee Cage Fabric & Insect Screening

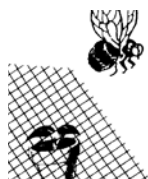

Please call 1-800-477-4744 for more information

Product	Composition	Intended Use	Shade %	Air Flow Reduction	Width
Econet B	Polyester	Insect screen	10%	5%	13.8'
Econet L	Pol/Acrylic	Insect screen	15%	23%	10.5'
Econet M	Polyester	Insect screen	15%	35%	10.8'
Econet T	Pol/Acrylic	Insect screen	15%	47%	11.2'
Econet S	Polyester	Insect screen	15%	60%	11.2'





**"From native plants to vegetables; our plants grow faster in EarthPots®."**

— Minto Island Growers  
Salem, OR



**Are you Growing in EarthPots?  
*What are you waiting for?***

**Apples to Zinnia  
Azaleas to Zucchini**

**Everything that grows *roots*  
grows *better* in EarthPots**

**Increase Productivity  
Grow Profits with EarthPots**

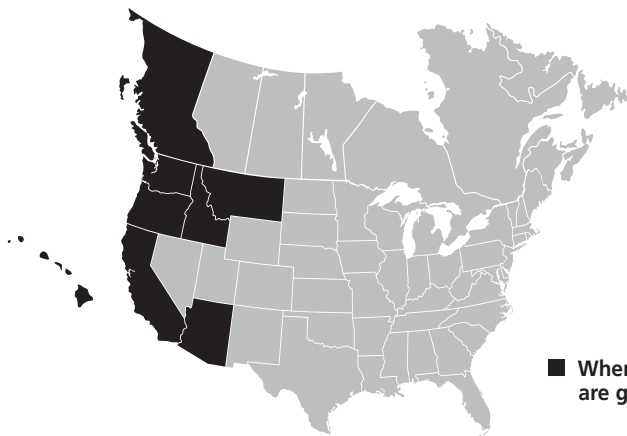

■ Where EarthPots® are growing





## 90mm EarthPots®

Cedarglen Floral Co.  
Damascus, OR

EARTHPOTS



Prod. Code	Dimensions	Cu. in. / Plug	Tray Count
PPER2035	20mm x 35mm	1.17	209
PPER2040	20mm x 40mm	1.34	162
PPER2035	20mm x 35mm	1.17	162 punchable
PPER2047	20mm x 47mm	1.53	162 deep
PPER2040	20mm x 40mm	1.34	144
PPER2340	23mm x 40mm	1.77	128
PPER2355	23mm x 55mm	2.4	128 deep
PPER2340	23mm x 40mm	1.77	105
PPER2340	23mm x 40mm	1.77	102
PPER2340	23mm x 40mm	1.77	102 strip
PPER2340	23mm x 40mm	1.77	2 x 51
PPER2340	23mm x 40mm	1.77	84
PPER3040	30mm x 40mm	3.02	78 strip
PPER3040	30mm x 40mm	3.02	3 x 26
PPER3040	30mm x 40mm	3.02	72
PPER3540	35mm x 40mm	4.1	72
PPER3560	35mm x 60mm	6.16	72 deep
PPER3545	35mm x 45mm	4.62	50
PPER35110	35mm x 110mm+	11.5+	98 deep basket
PPER4040	40mm x 40mm	5.4	50
PPER4047	40mm x 47mm	6.2	50 deep
PPER4545	45mm x 45mm	7.64	32
PPER4560	45mm x 60mm	10.2	50 deep
PPER45110	45mm x 110mm+	18.6+	38 deep/50 basket
PPER5070	50mm x 70mm	14	32 deep
PPER6070	60mm x 70mm	21	21
PPER60150	60mm x 150+	69+	20 deep basket
PPER7070	70mm x 70mm	28.7	18
PPER8070	80mm x 70mm	38	10
PPER9090	90mm x 90mm	61	15

## EARTHPOTS®

EARTHPOTS® are unique propagation plugs that retain vital air space needed for successful rooting. The fabric sleeve that surrounds the EARTHPOTS® is 100% degradable. The sleeve allows roots to easily grow through and air prune. EARTHPOTS® allow propagated plants to be easily removed from their trays and transplanted with no transplant shock. EARTHPOTS® save time and money in all steps of production - from propagation to finished product. Custom lengths and certified organic soils are available.

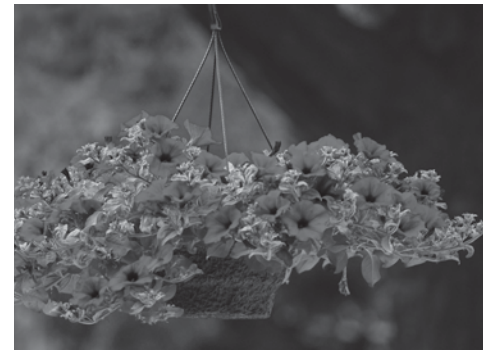

Product Code	Description	Max. Liq. Volume	Count	Weight/Lbs.
PPW100112	6" RND x 6" Dp	2.48 qt / 2.351 L	44	13
PPW100512	7" RND x 9" Dp	1.28 gal / 4.87 L	40	17
PPW100912	8" RND x 6" Dp	1.04 gal / 3.94 L	68	26
PPW101114	8" RND x 8" Dp	1.62 gal / 6.14 L	40	18
PPW101312	9" SQ x 9" Dp	1.99 gal / 7.55 L	50	37
PPW101412	10" RND x 7" Dp	1.80 gal / 6.84 L	40	26
PPW101612	10" RND x 10" Dp	2.55 gal / 9.68 L	36	31
PPW101912	11" SQ x 11" Dp	3.77 gal / 14.30 L	36	40
PPW102312	12" RND x 11" Dp	3.40 gal / 12.90 L	32	35
PPW102512	12" RND x 16" Dp	5.73 gal / 21.70 L	26	40
PPW102712	13" RND x 9" Dp	4.12 gal / 15.60 L	36	39
PPW103312	15" RND x 13" Dp	6.55 gal / 24.80 L	16	31
PPW103412	14" Garden Planter	5.20 gal / 19.70 L	16	36
PPW103512	15" RND x 16" Dp	7.97 gal / 30.20 L	14	28
PPW103712	18" RND x 12" Dp	9.90 gal / 37.50 L	12	39
PPW103812	18" Garden Basket	5.99 gal / 22.70 L	20	39
PPW103912	18" RND x 16" Dp	12.15 gal / 46.00 L	10	33
PPW104012	21" RND x 12" Dp	12.15 gal / 46.00 L	10	40
PPW104112	21" RND x 16" Dp	16.11 gal / 61.00 L	8	38
PPW104309	24" RND x 18" Dp	23.38 gal / 88.50 L	1	8
PPW104522	10" SQ HB	1.84GAL/6.98L	22	25
PPW105112	10" RND HB	1.34 gal / 5.10 L	22	18
PPW105512	12" RND HB	2.09 gal / 7.93 L	22	25
PPW105612	15" DEC-A-POT 8" Dp	3.93 gal / 14.90 L	22	24
PPW105712	M.W. Box 15" x 7" x 5" Dp	1.29 gal / 4.90 L	40	32
PPW105812	W. BOX 25" X 10" X 5"	2.98GAL/11.3L	24	32
PPQ105912	12"SQ HB	2.80 gal / 10.60 L	22	37
PPW106612	12" Cascade Basket	2.34 gal / 8.87 L	22	22
PPW106709	30" RND x 22" Dp	45.04 gal / 170.50 L	1	13
PPW106912	16" x 8" Gar. Bskt.	4.43 gal / 16.80 L	20	31
PPW107009	36" RND x 22" Dp	70.67 gal / 267.5 L	1	19
PPW107112	14" XL RND HB	3.96 gal / 15.00 L	20	27
PPW107312	10" Garden Planter	2.13 gal / 8.07 L	16	20
PPW107712	10" XL II RND HB	1.59 gal / 6.054 L	22	23
PPW107812	12" XL II RND HB	2.69 gal / 10.20 L	22	31
PPW109612	10" Bell Series	1.90 gal / 7.21 L	16	19
PPW109712	12" Bell Series	3.35 gal / 12.71 L	16	28
PPW109812	14" Bell Series	5.28 gal / 20.01 L	16	37





Product Code	Description	Max. Liq. Volume	Count	Weight/Lbs.
PPW109912	16" Bell Series	7.91 gal / 29.9 L	10	32
PPW888111	16" Gar. Bskt. Hg. Assm.		20	23
PPW888211	18" Gar. Bskt. Hg. Assm.		20	23
PPW888514	4 St. Nylon Hanger, 10" & 12"		22	2
PPW888899	4 Wire Tw. HK MTL Hanger		1	.05
PPW108112	Molded Fiber 6pk Carrier		50	10
PPW108312	Molded Fiber 5pk Carrier		50	8



## Tex-R Geodisc™

A revolutionary product designed to help control weeds in your containers. Cuts labor costs allowed for weeding your containers with herbicides and/or by hand. Economical and environmentally friendly.



Product Code	Description	Quantity/Box	Weight/Pallet	Box/Pallet
MSTEXGEO065II	Geodisc 6.5"	4,500	460	12
MSTEXGEO070II	Geodisc 7"	4,500	515	12
MSTEXGEO080II	Geodisc 8"	4,500	640	12
MSTEXGEO090II	Geodisc 9"	4,500	555	8
MSTEXGEO100II	Geodisc 10"	2,000	480	12
MSTEXGEO110II	Geodisc 11"	2,000	555	12
MSTEXGEO120II	Geodisc 12"	2,000	640	12
MSTEXGEO130II	Geodisc 13"	2,000	525	8
MSTEXGEO140II	Geodisc 14"	2,000	590	8
MSTEXGEO150II	Geodisc 15"	500	290	12
MSTEXGEO160II	Geodisc 16"	500	320	12
MSTEXGEO180II	Geodisc 18"	500	380	12
MSTEXGEO195II	Geodisc 19.5"	500	460	12
MSTEXGEO210II	Geodisc 21"	500	515	12
MSTEXGEO240II	Geodisc 24"	500	640	12
MSTEXGEO SQ0512II	Geodisc Square 5.5"	8000	860	12
MSTEXGEO SQ0600II	Geodisc Square 6"	4,500	490	12
MSTEXINS1601	16" x 16" Pieces Non-Woven	400	415	12
MSTEXINS1801	18" x 18" Pieces Non-Woven	400	523	12
MSTEXINS2401	24" x 24" Pieces Non-Woven	400	933	12
MSTEXINS3601	36" x 36" Pieces Non-Woven	400	525	3
MSTEXPROP44OZ1831001	1.83M x 100M (6' x 328') S/C	1	280	10
MSTEXPROP44OZ183301	1.83M x 30M (6' x 100') S/C	1	160	20
MSTEXPROP44OZ1221001	1.22M x 100M (4' x 328') S/C	1	366	20
MSTEXPROP44OZ122301	1.22M x 30M (4' x 100') S/C	1	198	36





## ITML Horticulture Products

Product Code	Description	Count	Wt. Lbs.	CS/Pallet
PPIPA.0600	PA.06000 6" Panterra Pot	350	34	32
PPIPA.0800	PA.08000 8" Panterra Pot	250	47	20
PPIPA.1000	PA.10000 10" Panterra Pot	100	34	34
PPIPA.1200	PA.12000 12" Panterra Pot	50	30	36
PPIPAD1200	PAB12000 12" Panterra Bowl	50	15	48
PPIPAD1400	PAB14000 14" Panterra Bowl	50	22	27
PPIHSI.1200GR	HSI12007 12" Swurl HP w/ Div GR	50	27	32
PPIHWP4LSNCL	HWP4LSNO22" 4-Strand Snap Poly Hanger GR	25/bndl		
PPIHWP3LSNOGR25	HWP3LSNO 18.5" 3-Strand Poly Hanger GR	25/bndl		
PPIHWS.L240	HWS.L240 24" Wire Hanger	50/bndl		
PPIHWP4LSNGR25	HWP4LSNO 22" 4-Strand Snap Poly Hanger GR	500		
PPISQL0550	SQL0550 5.5" Kordlok Square	200	30	40
PPIIKM0606BL	IJ06065 Deep Insert Black	100	18	72
PPIIKN0606BL	INA06065 Traditional 606 Insert Black	100	19	72
PPIIKN0804BL	INA08045 Traditional 804 Insert Black	100	20	72
PPIIKN0806BL	INA08065 Traditional 806 Insert Black	100	20	72
PPIIKN1204BL	INA12045 Insert Black	100	19	72
PPIIKN1801BL	INA18015 1801 Insert Black	100	20	72
PPITKP1835	TKP1835 3.5" 18 Pckt Tray Black	50	18	54
PPITRK1540(QL)BL	TRK15400 15 Pocket Tray Quickloc Blk	50	18	56
PPIAZE04500	AZE04500 4.5" Elite/Ultra Azalea	1000	35	36
PPIAZE05000	AZE05000 5" Elite/Ultra Azalea	750	34	40
PPIAZE0600GR	AZE06000 6" Elite/Ultra Azalea	520	36	40
PPISQK0400BL	SQK04005 4" Kord Lite Sq Pot Blk	960	36	48
PPISQL0450BL	SQL04505 4.5" Kordlok Sq Black	510	38	35
PPISQL05500BL	SQL05505 5.5" Kordlok Sq Blk	200	29	40

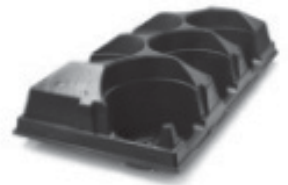

Swurl® Hanging Baskets



## Dillen Products

Product Code	Description	Count	Wt. Lbs.	CS/Pallet
PPIDILTCS08550	DILLEN TCS08550 8 PKCT TRAY FOR 2 QT BLACK	50	19	36
PPIDILXSQ05500BL	DILLEN XSQ05500 2 QUART POT BLACK	200		32
PPIDILCPB12000	DILLEN CPB12000 12.00 COLOR BOWL	42	19	48
PPIDILCPB16000	DILLEN CPB16000 16.00 COLOR B OWL	25	21	30
PPIDILCPA06003	DILLEN CPA06003 06.00 COLOR POT TL	98	14	66
PPIDILCPA10000	DILLEN CPA10000 10.00 COLOR POT TL	58	12	50
PPIDILCPA12001	DILLEN CPA12001 12.00 COLOR POT 2 TL	40	25	32
PPIDILCPA1400	DILLEN CPA1400 14.00 COLOR POT	20	23	36
PPIDILCDA14000	DILLEN CDA14000 14.00 CORDOVA POT	22	21	36
PPIDILMIP10000	DILLEN MIP10000 10.00 MILANO PLTR	50	23	50
PPIDILCPP12000	DILLEN CPP12000 12.00 OVAL COLOR PLTR	88	23	48
PPIDILCPP16000	DILLEN CPP16000 16.00 OVAL COLOR PLTR	43	23	30
PPIDILTCS15451	DILLEN CTS4515PF (PRESS FIT)	50	20	28
PPIDILXNS0T1G1BKBK	DILLEN XNS0T1G2 1.00 T1G SQUAT COEX PLS	140	9	48
PPIDILCDH14000	DILLEN CDH14000 14" CORDOVA PANTERRA	22	21	32
PPIDILXSQ05500	DILLEN XSQ05500 2 QUART POT TC/BLACK	200		32
PPIDILIJA06060	DILLEN IJA06060 DJ606 JUMBO BLACK	100	17	36
PPIDILULH12000	DILLEN ULH12000 1200 ULTRA HB	50	19	48



**Note:** Other sizes and styles available (including "ProCal" and 'Listo' style), please call for more information.



## Poly Cans

Poly cans are sold by the stack. Most sizes available in green & black. Please call for details.



Prod. Code	Size	Description	No. In Stack	Wt. Can Lbs.
PPALPC	4"x 3-1/2"	Little poly can side & bottom drain	250	0.060
PPA01W	6"x 5"	Welsh pot	50	0.285
PPA01D	6-3/8"x 7"	#1 Deep	25	0.180
PPA02D	8-1/4"x 8-1/2"	#2 Deep	25	0.688
PPA02S	8-1/4"x 6-1/2"	#2 Short	25	0.375
PPA03D	10-1/4"x 9-1/4"	#3 Deep	25	1.100
PPA03S	10-1/4"x 8"	#3 Short	25	0.800
PPA05D	10" x 12"	#5 Deep	15	1.330
PPA05S	12" x 10"	#5 Short	15	1.200
PPA06S	13-3/4"x 9-3/4"	#6 Short	15	1.500
PPA07	13-3/4"x 11-1/2"	#7 Deep	15	1.500
PPA10S	17-1/2"x 11-3/4"	#10 Short	15	2.600
PPA15SBL	19" x 15"	#15 Short	10	2.600
PPA20SB	22" x 16-3/4"	#20 Short	5	3.600

## Round Standard Pots

Round standard pots are sold by the case only. Saucers are available for round pots; sizes 4" to 16". Available in Green, White and Terra Cotta may also be available, please call for details.



Prod. Code	Size	Description	No. In Case	Wt. Case
PPAR212S	2-1/2"x 2-1/2"	Round standard	1368	26
PPAR3S	3"x 3"	Round standard	480	19
PPAR4S	4"x 4"	Round standard	342	19
PPAR414S	4-1/4"x 4"	Round standard	333	29
PPAR5S	5"x 5"	Round standard	198	30
PPAR6S	6"x 6"	Round standard	136	20
PPAR434	4"x 3"	Round 3/4	234	16
PPAR51234	5-1/2"x 4-3/8"	Round 3/4	150	27
PPAR634	6"x 4-3/4"	Round 3/4	148	18
PPAR61234	6-1/2"x 4-1/2"	Round 3/4	132	21
PPAR71234	7-1/2"x 5-3/4"	Round 3/4	72	29
PPAR812S	8-1/2"x 6-3/4"	Round standard	24	11
PPAR1012S	10-1/2"x 8-3/16"	Round standard	14	13
PPAR1212S	12-1/2"x 9-3/4"	Round standard	14	13

## Poly Flats

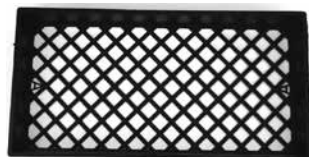

Prod. Code	Size	Depth Of Flat	Sold By Ctn: No. In Ctn.	Wt. Ctn. Lbs.
PPAFD	15-3/4"x 15-3/4"	5"extra deep	25	39.0
PPAFHD	18-1/2"x 14-1/4"	2-1/2"	25	31.25
PPAFS	17"x 17"	1-3/4"	50	26.0
PPAF1020	10"x 20"	2-3/8"	25	12.5
PPAFHD1412*	18-1/2"x 14-1/2"	2-1/2"	25	31.25
PPAFSD	17"x 17"	4"	25	27

\* Minimum order of 2000 flats

## Square Pots Bottom Drainage

Prod. Code	Size /Desc.	No. In Case*	Wt. Case Lbs.	Heavy Duty**	17x17**	10x20**
PPASQBD4	4"x 3-1/2" Square	279	16	12	16 Perf	10

\*Sold By Case \*\*No. Pots That Fit In a Flat



## Square Pots Side Drainage

Prod. Code	Size /Desc	Case Qty**	Wt./Case	Heavy Duty***	17x17***	10x20***
PPASQSD418	4-1/8"x 4"	243	24 lb	12	16	10
*PPASQSD31116	3-11/16"x 3-1/2"	300	20 lb	20 Perf	16	15 Gap
PPASQSD234	2-3/4"x 2-7/8"	984	41 lb	35	36 Perf	21 Gap
*PPASQSD214	2-1/4"x 2-1/2"	950	30 lb	48 Perf	49 Perf	36 Gap
*PPASQSD2	2"x 2-1/8"	1548	33 lb	63 Perf	64 Perf	50 Perf
*PPASQSD214R	2-1/4"x 3-1/4" rose pot	950	28 lb	48 Perf	49 Perf	36 Gap

\*Bottom of pots have 4 small drain holes. \*\*Sold By Case \*\*\*No. Pots That Fit In a Flat



## Square Band Pots

Prod. Code	Size /Desc.	No. In Case*	Wt. Case Lbs.	Heavy Duty**	17x17**	10x20**
PPABP3916	3-9/16"x 4"	348	23	20	15 Gap	18
PPABP234	2-3/4"x 2-1/2"	672	28	30 Perf	36 Perf	21 Gap
PPABP2932	2-9/32"x 2-5/8"x 2-1/2"	840	26	45 Perf	42 Perf	35 Perf
PPABP212	2-1/2"x 2-1/2"	864	30	35	36	32 Perf

Sold By Case \*\*No. Pots That Fit In a Flat



## Utility Band Pots Square/Crossed Bottom

Prod. Code	Size /Desc.	No. In Case*	Wt. Case Lbs.	Heavy Duty**	17x17**	10x20**
PPAUB3916	3-9/16" x 4-1/4"	348	18	20 Gap	15 Gap	18 Perf
PPAUB358	3-5/8" x 6"	128	18	20 Perf	16 Gap	10
PPAUB278	2-7/8" x 5-1/2"	200	18	30	36 Perf	21 Gap
PPAUB238	2-3/8" x 5"	325	18	48 Perf	49 Perf	36
PPALLB238334	2-3/8" X 3 3/4"	350	13	48 Perf	49 Perf	36
PPAUB234	2-3/4" x 2-1/2"	672	24	30 Perf	36 Perf	21 Gap
PPAUB2932	2-9/32" x 2-5/8"	840	26	45 Perf	42 Perf	36 Perf
PPAUB212	2-1/2" x 2-1/2"	864	30	35	36	32 Perf
PPAUB2	2" x 2-1/2"	756	25	63 Perf	64 Perf	50
PPAUB2789	2-7/8" x 9"	150	24	25 ea.	15-3/4" x 15-3/4" x 5"	
PPAUB4	4" x 10"***	1,540	402	9 ea.	15-3/4" x 15-3/4" x 5"	
PPAUB512	5" x 12"***	832	404	—	—	—
PPAUB58	5" x 8"***	1080	344	9 ea.	15-3/4" x 15-3/4" x 5"	

\*Sold By Case \*\*No. Pots That Fit In a Flat

\*\*\* Packaged on a pallet, customers must have forklift for unloading.





# Nursery Supplies

## Blow Molded Grip-Lip® Containers / Econo-Grip®

Grip-Lip containers are designed to provide maximum stacking and shipping strength. They ease the strain of maneuvering plants and trees because the lip becomes a rigid handle. The Econo-Grip® is an economical container with the same great features as the Grip-Lip.

### The Custom®

The Custom™ is our economy line of blow-molded containers. This container is designed to get your plants to market efficiently. All Nursery Supplies blow-molded containers carry a 2-year guarantee and some are available with smooth sides.



Prod. Code	Trade-Size	D(ID)	H	CCY	CI	GAL	L	PPS	Wt. Bndl
PPNSC100	—	4-3/4	4-3/4	850	54.9	.24	.90	140	7
PPNSC200	—	6	6	400	116.9	.51	1.9	125	9
PPNSC275	—	6-5/8	5-1/2	342	153.0	.59	2.3	100	8
PPNSC300S	#1	6-3/4	6-1/2	300	155.9	.68	2.6	75	10
PPNSC300	#1	6-3/4	7	270	173.2	.75	2.8	75	10
PPNSC350	Small Mum Pan	8	5	260	180.1	.78	3.0	130	15
PPNSC400	Full #1	7	7	210	225.2	.98	3.7	77	11
PPNSC550	Large Mum Pot	9	6	166	280.6	1.2	4.6	100	16
PPNSC600	#2	9	8 1/2	125	374.6	1.6	6.1	60	11
PPNSC816	Citrus Pot	8	16	84	553.5	2.4	9.1	50	27
PPNSC1000S	—	10	7-3/4	104	450.0	1.9	7.4	75	17
PPNSC1000	Foliage Pot	10	9	90	526.0	2.3	8.6	68	18
PPNSC1200S	—	11	7-1/2	89	522.0	2.3	8.6	52	19
PPNSC1200	#3	11	9-1/2	70	699.0	2.9	10.8	45	18
PPNSC1400	#5 Egg Can	10-1/2	12	60	796.0	3.5	13.1	33	18
PPNSC1600S	—	12	7-3/4	68	685.0	3.0	11.2	47	25
PPNSC1600	#5 Handles	12	10-1/4	58	810.0	3.5	13.3	47	21
PPNSC2000	#5 Handles	12	11 1/4	50	945.0	4.1	15.5	44	20
PPNSC2100	#5 Squat Handles	13-3/4	10	43	1,080.0	4.7	17.7	45	30
PPNSC2800	#7 Squat Handles	14	11-1/2	35	1,337.0	5.8	21.9	45	29
PPNSEG2800	#7	13 3/4	12	31	1,502.0	6.5	24.6	40	33
PPNSGL2800	#7	13 3/4	12	31	1,502.0	6.5	24.6	40	45
PPNSEG6900S	#15 Squat	17 1/4	12 1/4	19	2,492.0	10.8	40.9	19	31
PPNSGL6900S	#15 Squat	17 1/4	12 1/4	19	2,492.0	10.8	40.9	19	45
PPNSEG6900	#15	17 1/4	15 1/4	14	3,049.0	13.2	50.0	18	32
PPNSGL6900	#15	17 1/4	15 1/4	14	3,049.0	13.2	50.0	18	41
PPNSEG8000	#20	19 1/2	17	10	4,520.0	19.6	74.2	16	38
PPNSGL8000	#20	19 1/2	17	10	4,520.0	19.6	74.2	16	51
PPNSEG10000S	#20 Squat	22 3/4	13 1/4	10	4,738.0	20.5	77.7	14	34
PPNSGL10000S	#25 Squat	22 3/4	13 1/4	10	4,738.0	20.5	77.7	14	44
PPNSEG10000	#25	22 3/4	18 1/4	7	6,373.0	27.6	104.5	10	33
PPNSGL10000	#25	22 3/4	18 1/4	7	6,373.0	27.6	104.5	10	44
PPNSC18000	#45 Handles	30	20	4.5	10,463.0	45.3	171.5	5	37
PPNSC26000	#65 Handles	30-3/4	23	3.3	14,017.0	60.7	229.7	5	42

Call or go online for large quantity orders, additional info and current prices.

## Poly-Tainer™ Cans

Poly-tainer™ cans are injection molded for strength and rigidity. This sturdy container is strong enough for shipping and attractively styled for selling.

Prod. Code	Trade-Size	D(ID)	H	CCY	CI	Gal	L	PPS	Wt. Bndl
PPNSIM01	#1	6	7	270	173	.75	2.84	60	12
PPNSIM02P	#2	8 1/2	8 1/2	125	377	1.6	6.19	50	23
PPNSIM03P	#3	10	9 1/4	73	637	2.8	10.44	45	33
PPNSIM05S	#5 Squat	11	10	55	848	3.7	13.91	35	35
PPNSIM07S	#7 Squat	15	11 3/4	24	1,908	8.3	31.27	15	29
PPNSIM10S	#10 Squat	15	15	20	2,310	70.0	37.9	14	42
PPNSIM15S	#15 Squat	17 1/4	15	16	2,854	12.4	46.78	13	49

L: Liter | CI: Inches | D: Diameter | H: Height | GAL: Gallon (Actual Volume) | PPS: Pieces per Stack  
 CCY: Number of containers necessary to hold a cubic yard of soil | (SS): Smooth Sided

**Note:** All blow-molded containers are measured OD.

## Nursery Supplies, Inc. Accelerator®



\*Non-Stocked Items

Prod. Code	Description	Trade Size	Top Dia	Hgt	Gallon	Qt	Fl Oz	L	mL	CCY
PPNSAPAP62	Root Trainer® liner cell	SP #2	3	4	0.062	0.250	8	0.236	236	3,231
PPNSAPAPL2PT	TreePorter® Plastic Tray Holds 32 AP-L2	—	27 x 13½	6	—	—	—	—	—	—
PPNSAPAP3	#3 Accelerator® Air Root Pruning Container	#3	12	8	2.679	10.718	343	10.143	10,143	75
PPNSAPAP3BG	Bottom Grid for AP-3	—	9½	1	—	—	—	—	—	—
PPNSAPAP10	#10 Accelerator® Air Root Pruning Container	#10	18	12	9.351	37.406	1,197	35.399	35,399	22
PPNSAPAP15	#15 Accelerator® Air Root Pruning Container	#15	18	15½	12.000	48.000	1,536	45.424	45,424	17
PPNSAPAP30	#30 Accelerator® Air Root Pruning Container	#25	24	15¾	22.500	90.000	2,880	85.171	85,171	09

## Oasis Grower Products



Prod. Code	Description	Size	Cells
PPOSMO5010	#5010 Rootcubes	1¼" Medium	104 cells/sheet (20 sheets/case)
PPOSMO5231	#5231 Hortcubes	1" Thin Cut Medium	76 cells/sheet (20 sheets/case)
PPOSMO5625	#5625 Wedge	34 Ct. Dbl strip	72 strips/case
PPOSMO5615	#5615 Wedge (Medium Only)	Refill for 5625, 5641, 5643	120 strips/case



## T.O. Trays & Inserts

Vacuum-formed plastic products including a full line of containers from flats to inserts, plug trays to propagation trays, and pots to specialty items.

Prod. Code	Description	Case Qty.	Size	Weight	Volume Dry (cu. in.)	Max Liquid
PPTOPT12865	PL-072 Star DP Plug Tray	50	1.56" x 3"	20	4.39	2.43 (fl. oz)
PPTOPT12572	TO #12572 PROP-72	100	2.31" x 1.46"	23	2.5	1.39 (fl. oz)
PPTOPT720487C	TO #PL-128-Plug Tray Net	100	8" x 16"	40	1.53	.85 (fl. oz)
PPTOPT720520C	TO #PL-200-2.125-Plug Tray Net	50	10" x 20"	21	1.16	.64 (fl. oz)
PPTOPT720568C	TO #720568 PL-050 Star 4/5 Dpt	50	5" x 10"	30	9.02	6.08 (fl. oz)

**OBC NORTHWEST, INC.**  
Nursery & Greenhouse Supplies

Your Complete Source for  
Greenhouse, Nursery and  
B&B Supplies and  
Accessories since 1954



## Wire Hanging Baskets

This attractive, dark green wire hanging basket is the ideal answer for planting fuchsias, begonias, strawberries, tomatoes, and other bush-type plants. Light-weight, easy-to-hang and no breakage. Hangers included. Sold by the case (25 per case). No liner included.

Prod. Code	Size	Wt. Lbs.
PPOWMB12	12" Moss Basket w/ 4 wire, 21" Hanger	32.5
PPOWMB14	14" Moss Basket w/ 4 wire, 21" Hanger	38
PPOWMB16	16" Moss Basket w/ 4 wire, 27" Hanger	56

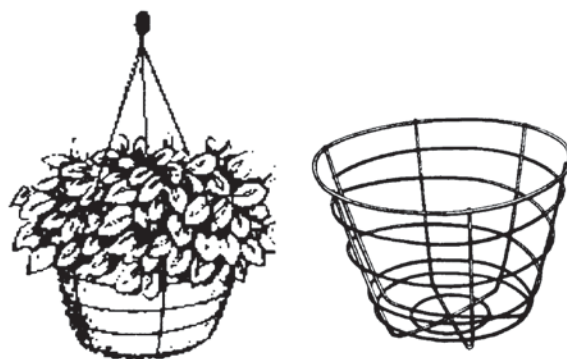

## Wire Hanger

Prod. Code	Style	Sold By Bdl.	Wt. Lbs.
PPOW4W24	4-Wire, Collar Hook Hanger, 24" long	50	12



## Al's Flower Pouch

Designed to maximize space, it can be hung on walls, decks, lamp posts, around swimming pools, on balconies or under gutters. Precut slits for planting rootballs. Made of green recyclable plastic. Sold in bundles of 25. 10 bundles per case. Standard: 8-1/2" x 20"/10 slits. Mini: 8-1/2" x 13-1/2"/ 6 slits. Standard size soil volume: 6 liters, Mini: 4 liters.

Prod. Code	Description	Unit of Meas.	Wt/Lb
PPFPE	6L 8.5"x 20", 10 slits	25/BNDL	1
PPFPC	6L 8.5"x 20", 10 slits	250/cs	10
PPFPME	4L 8.5"x 13.5", 6 slits	25/BNDL	0.5
PPFPMC	4L 8.5"x 13.5", 6 slits	250/CS	5

## Natural Tree Moss

These blankets of decorative moss are suitable where large pieces or quantities of moss are needed. Moss is removed from the tree, compressed and packed without removal of forest residue. Moss comes packaged in compressed pony bales. (3.25 cu. ft.)

Prod. Code	Wt. Lbs.
MSMTM	25







## Sabert Dura Pots

Economical Dura-Pots are made from durable polyethylene and come in 4 standard sizes. All sizes available in black. They are flexible for easy de-potting with rounded edges to prevent cuts. Pots are sold by the case. Call 1-800-477-4744 for information. (Formerly "Gage" Dura Pots)

Prod. Code	Width	Depth	Inside Diameter (in)	Volume	Inside Diameter (cm)	Volume (cc)	No. In Case	Case Wt. Lbs.
*PPG350	3-7/16"	3-1/4"	3.38	30.0	8.57	491.7	1,500	25
*PPG311	3-11/16"	3-3/8"	3.45	35.0	8.76	573.7	1,500	27
**PPG4	4"	3-3/8"	3.90	46.0	9.91	753.9	1,500	29
**PPG550	5-1/2"	5-1/2"	4.88	100.0	12.38	1639.0	400	27

\* 24 cases per pallet  
 \*\* 28 cases per pallet

## Amaroo Specimen Tree Boxes

These reusable containers feature root directors to avoid root circling and air vents for ample drainage and root pruning. Easy assembly/disassembly and a 4-way fork-liftable base saves labor.

Customized options are available, including: Drainage vents, Multiple colors and Customer name/phone number. Call for more details.



Prod. Code	Description	Inside Top	Inside Bottom	Outside Top	Outside Bottom	Inside Depth	Empty Weight	Pallet Qty.	Truck Qty.
PPTB16	16' (12 Gal)	16.5"	11.5"	N/A	N/A	15.5	7 lb.	180	4680
PPTB21	21" FB (25 Gal)	21.5"	17.5"	24.5"	18.5"	16.5"	10.5 lb.	111	2886
PPTB24	24" FB (35 Gal)	23"	17.5"	25"	18.5"	21.5"	12.5 lb.	80	2080
PPTB24D	24" Octagon	22.5"	17.5"	25"	18.5"	21"	12.5 lb.	80	2080
PPTB31	31" R (75 Gal)	31"	22.5"	34.5"	26"	22.5"	40.0 lb.	16	624
PPTB36	36" R (125 Gal)	35.5"	22.5"	38.75"	26"	32"	60.0 lb.	8	480
PPTB36S	36" S (130 Gal)	36"	28.75"	39.5"	32"	25.5"	40.0 lb.	14	672

## TDI Custom Plant Containers

All TDI planting sleeves, seed bags, plant bags and color containers are extruded from Virgin polyethylene which guarantees maximum greenhouse and field life.

**PLANTING SLEEVES** for field use are available in two colors: BLACK for locations where soil heat retention is desirable, or not a problem. (Average field life 18 - 24 months)

YELLOW with Ultra-Violet Inhibitors for locations where soil heat retention must be minimized. (Average field life 10 - 16 months)

**GREENHOUSE SEED BAGS** for Avocado, Citrus, Kiwi, Christmas Trees, etc. are available in two standard sizes:

2-1/2" x 2" wide x 9-1/2" long x .003 mil for larger seed,

2" x 1-1/2" wide x 9-1/2" long .003 mil for smaller seed.

Both sizes are provided with 24-32 drainage holes per bag. Standard colors: Yellow and Black.

**GREENHOUSE PLANT BAGS** a low cost replacement for rigid containers, are now available in both 1 Gallon and Egg Can sizes

**Product Code: PPTDI**

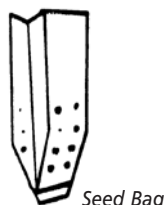
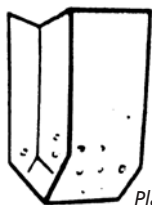

## Growing Systems Growing Trays

Growing trays are available in many sizes and styles to match a wide variety of needs from flowers and tree seedlings to vegetables and more. Manufactured from the highest quality virgin resins. Special modifiers have been added and designed for great durability. Drainage holes are clearly punched and are available in several diameters. All trays are made of high-impact polystyrene, and measure 10" x 20". The Groove Tube Tray has sharp grooves extending the length of the cell wall to the bottom of the tray. This eliminates root circling prior to air pruning. Other sizes and types of trays available. Sold by case.

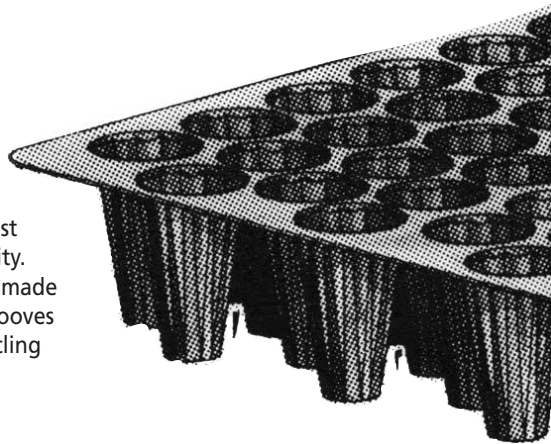

Call 1-800-477-4744 for price information.

Prod. Code	Description	Cell Size: Diameter x Depth	Size: Drain Hole	Gauge	Case Wt. Lbs.	Qty. Case
PPGSF135	Growing tray	1-1/8" x 1-1/2"	9/16"	24	24	100
PPGSGT38412	Deep groove tube	2-1/4" x 4-1/2"	1-1/16"	45	24	50
PPGSGT38D	Deep groove tube	2-1/4" x 5"	13/16"	45	24	50
PPGSGT51D	Deep groove tube	1-7/8" x 3-1/2"	11/16"	30	15	50
PPGSGT73	Groove tube	1-1/2" x 2-3/4"	11/16"	24	24	100
PPGSTT96	Tube tray	1-3/8" x 2 1/2"	1/4"	30	30	100
PPGSGRT73	Growing tray	1-1/2" x 2-3/4"	11/16"	24	24	100
PPGSGRT7314	Growing tray	1-1/2" x 2-3/4"	1/4"	24	24	100

## Brown Kraft Paper Pot Sleeves

All natural brown kraft paper pot sleeves. Other sizes available by request. Sold by the case.

Prod. Code	Pot Size	Sleeve Ht.	Bottom Opening	Top Width	Wt./Cs./Lbs.	Qty. Case*
MSPS618	6"	18"	7-1/4"	16"	25	500
MSPS6520	6 - 6-1/2"	20"	8"	16"	27	500
MSPS8530	8 - 8-1/2"	24"	11"	30"	51	500

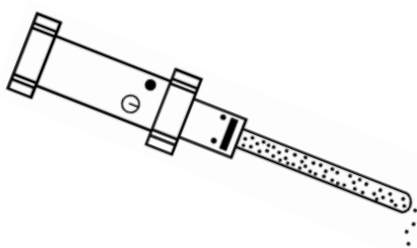

## Vibro Motor Hand Seeder

A seeding tool designed for small and medium-sized growers as well as home gardeners.

Prod. Code	Description	Wt. Lbs.
MSMHS	Hand Seeder	1
MSMHPSA2	Power Supply Adapter to replace battery	N/A
MSMHSTM3	Tip Magnifier	N/A

## Evergreen Vacuum Seeder

This seeder is light weight and very simple to use. This seeder self centers itself over top of the plug tray, for accurate seed location. Change seed plates and locator frames for different plug tray formats in seconds. Plants most vegetable, flower and tree seed.



Prod. Code	Description
MSEVS	Evergreen Vacuum Seeder (includes one plate)
MSEVSEP	Evergreen Vacuum Seeder Extra Plate (no seeder)
MSEVSLF	Evergreen Vacuum Seeder Locating Frame (no seeder)



Plug Popper

## Antal/Cayson Plug Popper

The Plug Popper dislodges your plugs from their tray in a matter of seconds. No more broken stems or damaged roots. This indispensable horticultural tool works with a simple foot-pedal operation.

No cords, hoses or motors to maintain. The Plug Popper is easy to use and handles any tray with the swap of an insert. Try it for yourself! You will find that this heavy-duty workhorse pays for itself in a single season.

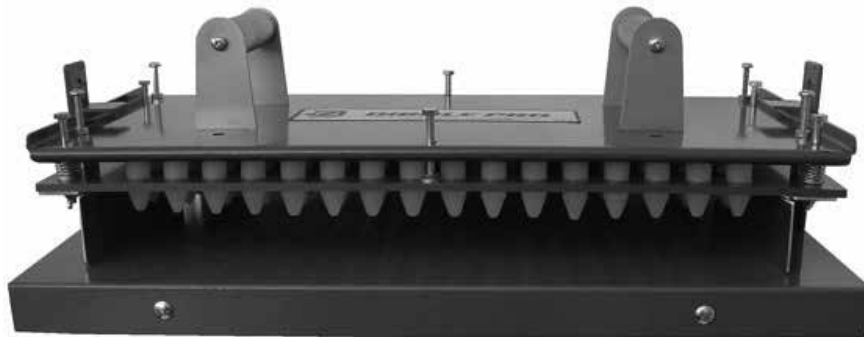

Dibble Pro



## Dibble Pro

- Aluminum Uni-Body Construction
- Plastic or Aluminum Pins
- Automatic Stripper Plate
- Durable Anodized Finish
- Makes A Perfect Dibble Every Time
- Use For Plugs or Cuttings
- Adjustable Depth Control

### SOIL TABLE FOR POTS, PACKS AND FLATS

Please bear in mind that while we've tried to be accurate, these figures have to be treated as approximations. Soil volumes may vary, depending upon the type of soil involved and the packing methods used. Actual pot dimensions will vary from one manufacturer to another.

#### POTS, BULB PANS

Pot Size	Approximate Dim. Top x Depth x Bottom	Pots Per Cu. Ft. Mix
<b>AZALEA POTS</b>		
4"	4 x 2-13/16 x 3"	56
4-1/2"	4-1/2 x 3-3/8 x 3-1/4"	44
5"	5 x 3-13/16 x 3-9/16"	28
5-1/2"	5-1/2 x 4-1/4 x 3-7/8"	24
6"	6 x 4-5/8 x 4-1/4"	18
6-1/2"	6-1/2 x 5 x 4-9/16"	16
7"	6-7/8 x 5-3/8 x 5-1/16"	12
7-1/2"	7-3/8 x 5-11/16 x 5-3/8"	10
8"	8-1/8 x 5-7/8 x 6"	7
8-1/2"	8-1/2 x 6-1/4 x 6-1/4"	6
10"	9-7/8 x 7-3/8 x 7-1/4"	4
<b>GERANIUM POTS</b>		
3-1/2"	3-1/4 x 3 x 2-3/8"	96
4"	3-15/16 x 3-7/16 x 2-7/8"	56
4-1/4"	4-1/4 x 3-9/16 x 3-1/8"	50
4-1/2"	4-3/8 x 3-7/8 x 3"	44
<b>SQUARE POTS</b>		
2-1/4"	1-15/16 x 1- 7/8 x 1-1/2"	257
2-1/2"	2-3/8 x 2-1/4 x 2"	208
3"	3 x 2-13/16 x 2-1/4"	120
3-1/2"	3-3/8 x 3-3/16 x 2-3/8"	80
4"	4 x 3-7/8 x 2-3/4"	48
4-1/2"	4-3/8 x 4-3/8 x 3"	40
5"	5 x 3-1/2 x 4-15/16"	28
5-1/2"	5-1/2 x 5-3/8 x 3-13/16"	20
6"	6 x 5-3/4 x 4-1/16"	16
7"	6-3/4 x 7-3/4 x 4-11/16"	10
8"	7-5/8 x 7-3/4 x 5-3/8"	6
10"	9-7/8 x 9-3/4 x 6-7/8"	3
<b>BULB PANS</b>		
6"	6-1/16 x 3-9/16 x 4-9/16"	24
7"	7-1/16 x 3-13/16 x 5-9/16"	16
8"	8-3/16 x 4 x 6-3/4"	9
10"	10-1/4 x 4-15/16 x 8-1/8"	5
12"	12-1/8 x 6 x 9-3/4"	3
<b>HANGING BASKETS</b>		
<b>LOCKWOOD HANGING BASKETS</b>		
8"	7-1/2 x 4-7/8 x 4-1/16"	11
10"	10 x 6-1/8 x 4"	5
Wall Pot	10-3/16 x 4-7/8 x 6-1/16"	10

### FLATS AND INSERTS

Type	Approximate Dimensions Width x Length x Depth	Units Per Cu. Ft. of Mix
<b>FLATS</b>		
<b>1020N, 1020R Series</b>		
	11-1/2 x 21-1/4 x 2-1/4"	4.6
<b>1020K (Germination)</b>		
	11-1/2 x 21-1/4 x 1-1/8"	7
<b>20-Row Seedling Tray</b>		
	11-1/2 x 21-1/4 x 1-1/8"	11
<b>STANDARD CELL-PAKS</b>		
804	2-3/8 x 2-3/8 x 2-1/4"	5.6
806	1-1/2 x 2-3/8 x 2-1/4"	6
1006	1-3/4 x 1-1/2 x 2-1/4"	5.4
1206	1-1/2 x 1-1/2 x 2-1/4"	9.2
1804	1-1/2 x 1-1/2 x 2-1/4"	9.2

#### PLUG TRAYS

Type	Inside Cavity Size	Units Per Cu. Ft. of Mix
<b>PRO-TRAY GROWING TRAYS</b>		
Six pak	3-1/8 x 3-1/8 x 3-1/2"	11.5
18 Pots (cut)	3-1/8 x 3-1/8 x 3-1/2"	69.1
24 Pots (cut)	3-1/8 x 2-1/4 x 3"	126.8
18 Liner Tray	3-1/8 x 3-1/8 x 3-1/2"	3.8
24 Liner Tray	3-1/8 x 2-3/16 x 3"	5.3
24 Pro-Tray	2-3/8 x 2-5/16"	10
38 Pro-Tray	2-3/16 x 2-5/16"	7.5
50 Pro-Tray	1- 7/8 x 2-5/16"	8
72 Pro-Tray	1-1/2 x 2-5/16"	9.4
98 Pro-Tray	1-3/8 x 1-1/2"	11.2
162 Pro-Tray	1 x 1-1/2"	14.5
288 Round Pro-Tray	13/16 x 1"	19.1
<b>PRO-STRIP</b>		
5/10	1-7/8 X 2-5/16"	39.8
<b>PLUG FLATS</b>		
50 Sq. Flat	1-7/8 x 2-1/4"	6.3
72 Rd. Flat	1-7/16 x 1-3/4"	12.8
72 Sq. Flat	1-9/16 x 2-3/16"	7.3
98 Sq. Flat	1-3/16 x 2"	7.9
128 Sq. Flat	1-3/16 x 1-13/16"	9
162 Sq. Flat	1 x 1-1/2"	9.2
200 Sq. Flat	5/16 x 1-1/2"	10.7
273 Sq. Flat	3/4 x 1-1/8"	18.6
288 Rd. Flat	13/16 x 1"	19.1
288 Sq. Flat	13/16 x 1-1/4"	15
392 Sq. Flat	5/8 x 7/8"	23.1
406 Sq. Flat	5/8 x 7/8"	22.2
512 Sq. Flat	9/16 x 3/4"	24.7

#### SOIL MIX VOLUMES

1 bushel = 1-1/4 cu. ft.  
 1 cu. yard = 27 cu. ft.  
 1 cu. yard = 22 bushels  
 100 sq. ft. of bench area  
 (at 6 in. soil depth) = 50 cu. ft. or 40 bushels of soil mix

### METRIC CONVERSIONS

To Convert From	To	Multiply By
<b>Gallons</b>	milliliters	3785.0
	cubic feet	0.1337
	liters	3.7853
<b>Grams</b>	ounces	0.03527
	fluid ounces	33.814
	quarts	1.05669
	gallons	0.2642
<b>Ounces</b>	grams	28.34952
	milliliters	29.57353
	liters	0.02957
<b>Pounds</b>	grams	453.59237
	milliliters	473.17647
<b>Pints (fluid)</b>	liters	0.47318
	quarts (dry)	cubic inches
<b>Quarts (fluid)</b>	milliliters	946.358
	liters	0.94633
	Yards	1.094
<b>METERS</b>		

#### PARTS PER MILLION

To determine parts per million (ppm) of an element in a fertilizer, simply multiply the percent of that element by 75. The answer will be the ppm of the element per ounce of the fertilizer in 100 gallons of water.

For instance, how much 20-20-20 fertilizer should you use to get a 200 ppm nitrogen solution?

EXAMPLE: 0.20 x 75 = 15 ppm (% of nitrogen element in fertilized multiplied by 75). 200 divided by 15 = 13.3 oz. (desired ppm solution divided by ppm per oz.).

13.3 oz. of fertilizer are required to produce a 200 ppm nitrogen solution in 100 gals of H2O.

#### LIQUID CONVERSIONS

1 pt./100 gal	=	1 tsp. /gal
1 qt./100 gal	=	2 tsp. /gal
1 teaspoon	=	1/3 tbsp, or 1/2 oz.
1 tablespoon	=	3 tsp, or 1/2 oz.
1 fluid ounce	=	2 tbsp, or 6 tsp.
1 cup	=	8 oz, 1/2 pint, 16 tbsp, 48 tsp.
1 quart	=	32 oz., 4 cups, 2 pints, 64 tsp.
1 gallon	=	4 qts, 8 pints, 16 cups, 128 oz.



## Customers

Customers who have established credit with OBC Northwest will receive net 30 days terms. Invoices are due 30 days from the invoice date and will be charged a late payment charge of 1.5% interest per month. All returned checks will be charged a \$25.00 handling fee.

## New Accounts

To establish credit, simply fill out the credit application enclosed and mail or fax to us. Please give satisfactory Trade References. Please allow two weeks to verify references. If purchases must be made and credit is not established, a payment will be required or cash upon delivery or pickup.

## Payment

Terms net 30 days unless otherwise stated on the invoice. Past due accounts will include interest at the rate of one and a half percent per month until paid and expenses of collection, including reasonable attorneys fees, whether or not litigation is commenced. If litigation is brought, customer agrees to jurisdiction of the Oregon courts. To our Net 30 day accounts; OBC does not accept the use of Credit Cards for any part of your outstanding balance.

## Returns

Authorization is required before returns will be accepted. All products returned must be accompanied with the invoice and returned in its original condition, unless product has not performed within written warranties. Goods must be returned within 30 days of shipment in order to receive credit. Goods that have been special ordered or that are not a stock item may not be returned unless prior arrangements have been made. Burlap cannot be returned. All returns will be assessed a handling charge of 20% unless otherwise authorized.

## Special Orders

A deposit of 50% is required on special orders. Customers are responsible for the cost incurred on special orders that are cancelled.

## Freight Claims

Freight claims must be filed immediately. Claims for lost or damaged materials and freight charges must be made with the transportation company. Claims for lost or damaged materials and transportation charges may not be deducted from our invoice, nor may payment of invoice be withheld awaiting adjustments of such claims, since it is the function of the freight company to guarantee safe delivery. Claims for missing or damaged products delivered by an OBC truck must be made immediately by calling the office at 1-800-477-4744.

## Limited Warranty

This warranty contains the entire agreement between the parties with respect to the products and goods subject hereto, which products have been assembled from goods supplied to seller by other manufacturers and dealers. Seller makes no representations or warranties expressed or implied relative to the products and goods, except that the products and goods sold here under are of the standard quality and specifications for such products and goods sold by seller. Buyer assumes all risk and liability resulting from the use of product and goods. If any sample was shown buyer, such sample was used mainly to illustrate the general type and quality of the product and goods. Seller makes no warranty that they are fit for any particular purpose or that they will endure for any particular length of time.

## Causes Beyond Seller's Control

Seller shall not be liable for failure to deliver or delays in delivery occasioned by causes beyond Seller's control, including without limitation strikes, lock-out, fire, inability to obtain materials or shipping space, break-downs, delays of carriers or suppliers, and governmental acts and regulations.

## Shipping

All supplies shipped F.O.B. our warehouse unless quantity shipments can be arranged direct from the manufacturer. We have no licensing requirements for purchases. Please see page 3 for our regular shipping schedule.

**Note:** *The fuel charge will vary depending on location; with an order of \$350 or more, we will deliver your order as follows: a fuel charge of \$20 on our local delivery route, \$50 will be applied for long distance deliveries, and \$60 for deliveries to Canada. For orders under \$350, a fuel charge of \$65 will be added. Orders need to be placed no later than 3:00 pm the day before delivery for stocked items. Canadian orders need to be placed by noon the Thursday before delivery.*

## Please Note:

OBC Northwest Inc. gladly accepts Visa or Master Card for purchases done at time of placing order. Visa or Master Card can be used in lieu of COD purchases. To our Net 30 day accounts; OBC does not accept the use of Credit Cards for any part of your outstanding balance.

## Burlap Definition:

The durability of the fabric depends on several factors like usage of different fibres, structure of the fibres and the soil condition. The fabric is manufactured from 100% natural jute fibres. This material decomposes completely in the soil. Durability: approx. up to 3 months. Indications on durability are based on average conditions. These may vary considerably, depending on soil condition, moisture levels and temperature. Durability can, therefore, not be guaranteed.

**- A -**

Acme Gravity Flow Spreader .....38  
 AgroFabric .....57  
 All-Weather Paper .....27, 42  
 Al's Flower Pouch .....71  
 Amaroo Tree Boxes .....7, 72  
 Ames Tools .....20-21  
 Anderson Die Plastic Pots .....66-67  
 Anti-drip Compound .....52  
 Apex Fertilizers .....35  
 Aprons .....42  
 ARS Tools .....16

**- B -**

B & B Supplies .....4-8  
 Back Pack Sprayers .....40  
 Bahco .....15  
 Baler Twine .....4  
 Bamboo Cane Stakes & Trellis .....14  
 Barnel Pruners .....16  
 Basket Liners .....4  
 Bastard File .....7  
 Batten Tape .....53  
 Bedding Pot Labels .....24, 26-27  
 Benches, Conley .....47  
 Bench Top Materials .....53  
 Bench Wire .....53  
 Binding Tape Tie Down .....53  
 Bird Netting .....28  
 Bird Scare Tape .....11  
 Black Plastic Mulch .....58  
 Blades, Max .....11  
 Bonsai & Craft Scissors .....16  
 Brushking Shearing Knives .....28  
 Budding Strips .....13  
 Burlap Squares & Liners .....4

**- C -**

Calipers .....8  
 Carts .....7, 34  
 Chainlock .....9  
 Check Valves .....39  
 Chemical Accessories .....40-41  
 Chemical Sprayers .....40  
 Chip Budding Tape .....10  
 Christmas Tree Supplies .....28  
 Circulation Fans .....52  
 Closure Strips .....55  
 Coco Fibre .....36  
 Cold Frame Greenhouses .....44-45  
 Conley Greenhouses .....46-47  
 Containers .....62-73  
 Container Cart .....7  
 Controllers & Instruments, Greenhouse 48-52  
 Convection Tube, Fan .....50  
 Convection Tube Hangers .....50  
 Conversion Tables .....75  
 Cooling Pads & Systems .....50  
 Corona Sharpening Tool .....13, 28  
 Corona Tools .....17  
 Coveralls, Spray .....40  
 Cowhide Driver Gloves .....42  
 Credit Application .....79  
 Crimper, Wire .....7  
 Crop Covers .....57

**- D -**

Delivery Schedule .....3  
 Delta-T Heating Systems .....49  
 Desktop Printer .....25  
 Dillen .....65  
 Doc Farwell's Tree Seal .....12  
 Doors .....47, 51  
 Dos-A-Cart .....39  
 Dosatron Fertilizer Injectors .....39  
 Dramm Syphonjet .....38  
 Dramm Watering Nozzles .....30-32  
 Dribble Rings .....30  
 Driver Gloves, Cowhide .....42  
 Dura-Bench Bench Top .....53

**- E -**

EARTHPOTS .....60-61  
 Environmental Controls .....48-49, 52  
 Erosion Net Staples .....58  
 Erosion Netting .....58  
 Exhaust Fans, Shutters .....50  
 E-Z Feeder Applicator .....38

**- F -**

Fans .....50, 52  
 Farm Tools .....20-21  
 Felco Pruning Shears & Saws .....18-19  
 Fertile Dispenser .....38  
 Fertilizer Applicators .....38  
 Fertilizer Injectors .....39  
 Fertilizers .....35  
 File, Mill Bastard .....7  
 Filters .....39  
 Flagging Tape .....11  
 Flag Stakes .....11  
 Flats .....66, 70  
 Flat Wire Baskets .....6  
 Flower Pouches, Al's .....71  
 Fog-It Water Nozzles .....32  
 Frost Protection .....57

**- G -**

Gage Dura Pots (see Sabert) .....72  
 Galvanized Stakes .....14  
 Gates Water Hose .....33  
 Geodisc .....63  
 Gilmour Watering Products .....33  
 Glove Liner, Cotton .....42  
 Gloves .....42  
 Goggles & Glasses .....40  
 Grafting & Budding Knives .....12  
 Grafting Seals .....12  
 Greenhouse Accessories .....50-55  
 Greenhouse Computer Controls .....48-49  
 Greenhouse Construction .....43  
 Greenhouse Films .....56  
 Greenhouse Heating Systems .....49  
 Greenhouse, OBC .....43-45  
 Greenhouse Parts .....51  
 Greenhouses, Conley .....46-47  
 Greenhouses, OBC .....44-45  
 Greenhouse Zippers .....54  
 Gripper Gloves .....42  
 Ground Cover .....58  
 Growing Systems Trays .....73  
 Gutter-Connect Greenhouses .....46-47

**- H -**

Hand Tools .....20, 22, 73  
 Hanging Baskets .....62-64, 71  
 Hanging Baskets, Wire .....71  
 Harrell's Fertilizer .....35  
 Heater Hangers .....51  
 Heating Systems .....49, 51  
 Hedge Shears .....15-17, 19  
 Hoes .....21-22  
 Hog Ring Stapler .....8  
 Holsters .....19  
 Honing Oil .....13  
 Horizontal Air Flow Fans .....52  
 Hormex Rooting Compound .....41  
 Hose & Accessories .....30-33

**- I -**

Impress-O-Tags .....23  
 Inflation Blowers .....54  
 Inflation Kit, Outside Air .....54  
 Inflation Kit, Retro Fit .....54  
 Injectors .....39  
 Insect Bug Screen .....59  
 Insect Trap .....41  
 Inserts .....70  
 Insta-Ties .....9  
 Irrigation Shovels .....20  
 Irrigation Supplies .....30-33  
 ITML .....64

**- J -**

Jack's Fertilizers .....35  
 Jersey Gloves .....42  
 Jumper Hose .....54  
 Jute Erosion Netting .....58

**- K -**

Kleen Guard Coveralls .....40  
 Knives .....8, 12, 28  
 Kraft Pot Sleeves .....73

**- L -**

Label Printing .....25  
 Labels .....23-27  
 Landscape Rakes .....21  
 Liner, Glove, Cotton .....42  
 Load Divider Netting .....28  
 Loppers .....15, 17, 19  
 Lubricant Spray .....19

**- M -**

Marking Pens .....26  
 Max Tape Products .....10-11  
 Measurement  
     Conversion Tables .....75  
 Micro-Grow Controllers .....48  
 Mist Kits .....52  
 Moss, Peat .....36  
 Moss, Tree .....71  
 Mounting Bracket, Fan .....54  
 Mulch, Black & Red .....58

**- N -**

Nails, Pinning . . . . . 8  
 Nitrile Gloves . . . . . 42  
 Neoprene Gloves . . . . . 42  
 Netting, Erosion . . . . . 58  
 Netting Staples . . . . . 58  
 Nursery Carts . . . . . 7, 34  
 Nursery Containers . . . . . 62-69, 72-74  
 Nursery Labels . . . . . 23-27  
 Nursery Squares . . . . . 4  
 Nursery Stakes . . . . . 14  
 Nursery Supplies Containers . . . . . 68-69  
 Nylon Sling . . . . . 7

**- O -**

OBC Greenhouse . . . . . 43-45  
 Oasis Grower Products . . . . . 69  
 Okatsune Shears . . . . . 15

**- P -**

Pack-It Tree Tote . . . . . 7  
 Paper Pot Sleeves . . . . . 73  
 Peat Moss . . . . . 36  
 Pens, Nursery . . . . . 26  
 Perfect-A-Feed Applicator . . . . . 38  
 Perlite . . . . . 36  
 Permanent ID Labels . . . . . 23  
 Ph Meters . . . . . 29  
 Pitch Fork . . . . . 21  
 Pinning Nails . . . . . 8  
 Plant Bags . . . . . 72  
 Plant Ties . . . . . 9  
 Plastic Mulch, Black & Red . . . . . 58  
 Plug Popper . . . . . 74  
 Pneumatic Stapler . . . . . 8  
 Pole Pruners . . . . . 16-17  
 Policies, Returns & Terms . . . . . 76  
 Polycarbonate . . . . . 55  
 Poly Film . . . . . 56  
 Poly Film Tie Down . . . . . 54  
 Poly Flats . . . . . 66  
 Poly Repair Tape . . . . . 53  
 Pots . . . . . 61-69, 72-74  
 Pot Labels . . . . . 24, 26-27  
 Pot Sleeves . . . . . 73  
 Potting Soil . . . . . 37  
 Power Tube Fan . . . . . 50  
 Pressure Sensitive Labels . . . . . 26  
 Printing Software . . . . . 25  
 Printers . . . . . 25  
 Printing, Labels . . . . . 25  
 Propagation Mats . . . . . 29  
 Propagation Supplies . . . . . 29  
 Pruner Grease . . . . . 19  
 Pruners, Long Reach . . . . . 16-17, 19  
 Pruning Saw . . . . . 16-17, 19  
 Pruning Shears . . . . . 15-19, 22  
 Pulp Pots . . . . . 62-65  
 Push-on Tags . . . . . 24  
 PVC Rain Gear . . . . . 42

**- R -**

Rain Wear . . . . . 42  
 Rakes . . . . . 21  
 Retro Fit Kit . . . . . 54  
 Ring Knives . . . . . 8  
 Rite in the Rain Notebooks . . . . . 27, 42  
 Rooting Compounds . . . . . 41  
 Rubber Bands . . . . . 8  
 Rubber Gloves . . . . . 42

**- S -**

Sabert . . . . . 72  
 Safety Glasses & Goggles . . . . . 40  
 Sato . . . . . 23-27  
 Saws . . . . . 16-17, 19  
 Schaefer Fans . . . . . 52  
 Scissors . . . . . 16  
 Seeders . . . . . 73  
 Shade Cloth . . . . . 59  
 Shading Compound . . . . . 52  
 Sharpening Stones . . . . . 13  
 Shearing Knives, Chaps . . . . . 28  
 Shears & Loppers . . . . . 15, 19-20  
 Sheaths . . . . . 12, 19  
 Shepherd Bench Wire . . . . . 47  
 Shipping Rubber Bands . . . . . 8  
 Shovels . . . . . 20-21  
 Shutters . . . . . 50  
 Signs, Sign Holders . . . . . 23  
 Slings, Nylon . . . . . 7  
 Slip-On Labels . . . . . 27  
 Soil Amendments . . . . . 36  
 Soil Mixes, OBC . . . . . 36-37  
 Soil Test . . . . . 29  
 Soil Thermometers . . . . . 29  
 Solo Sprayer . . . . . 40  
 Spades . . . . . 22  
 Spray Suits . . . . . 40  
 Spreaders . . . . . 38  
 Spring Lock . . . . . 51  
 Sprinklers . . . . . 30  
 Stapler, Hog Ring . . . . . 8  
 Stapler, Pneumatic . . . . . 8  
 Staples . . . . . 8, 11, 58  
 Stakes, Wire & Bamboo . . . . . 14  
 Sticky Strips . . . . . 41  
 Stretch Wrap . . . . . 7  
 Stretch Tie . . . . . 9  
 SunClear . . . . . 52  
 Square Pots . . . . . 62-64, 67, 72, 74  
 Syphonject . . . . . 38

**- T -**

Table of Contents . . . . . 1  
 T-Stakes . . . . . 26  
 Tally Meter . . . . . 28  
 Tapener Products . . . . . 10-11  
 Tapes . . . . . 10-11  
 TDI Plant Containers . . . . . 72  
 Temperature Controls . . . . . 48, 50, 52  
 Terms & Payment . . . . . 76  
 Texel . . . . . 63  
 Thermal Labels . . . . . 27  
 Thermal Printer . . . . . 25  
 Thermometers . . . . . 29  
 Thermostat . . . . . 48, 50, 52  
 Tie Downs . . . . . 54  
 Tie Tapes . . . . . 10  
 Tools . . . . . 20-22  
 T.O. Trays & Inserts . . . . . 70  
 Tracking Trailers . . . . . 34  
 Traps . . . . . 41  
 Trays . . . . . 63, 66, 70, 73-74  
 Tree Box . . . . . 7, 72  
 Tree Kote . . . . . 12  
 Tree Moss . . . . . 71  
 Tree Trunk Protectors . . . . . 8  
 Tree Wrap . . . . . 8  
 Truck Tarps . . . . . 59  
 Tube Fan . . . . . 50  
 Twine Knives . . . . . 8  
 Twines . . . . . 4  
 Tye Tape . . . . . 10

**- U -**

Utility Bands, Anderson Die . . . . . 67

**- V -**

Vacuum Seeder . . . . . 73  
 Vapor Guard . . . . . 41  
 Ventilation Control . . . . . 52  
 Vermiculite . . . . . 36  
 Vibro Seeder . . . . . 73

**- W -**

Wagons, Nursery . . . . . 34  
 Warrens T-7 Spreader . . . . . 38  
 Water Heating Systems . . . . . 49  
 Water Shed Rain Wear . . . . . 42  
 Water Soluble Fertilizer . . . . . 35  
 Water Wands & Breakers . . . . . 30-32  
 Watering Supplies . . . . . 30-33  
 Weather-Proof Notebooks . . . . . 27, 42  
 Web Flats . . . . . 66  
 Western Pulp . . . . . 62-63  
 Wire Baskets . . . . . 5-6  
 Wire Crimpers . . . . . 7  
 Wire Hangers . . . . . 71  
 Wire Hanging Baskets . . . . . 71  
 Wire Stakes . . . . . 14  
 Wooden Garden Labels . . . . . 24  
 Woods Rooting Compound . . . . . 41

**- Y -**

Yard Card Signs, Holders . . . . . 23

**- Z -**

Zippers . . . . . 54

# OBC NORTHWEST, INC.

NURSERY & GREENHOUSE SUPPLIES

PO BOX 759 CANBY, OR 97013  
Phone: 503-266-2021  
Fax: 503-266-6837

## CREDIT APPLICATION

The following information must be completed **IN FULL** and will be held in the strictest confidence. Please keep a copy for your records. STANDARD TERMS ARE NET 30 DAYS. Return fax 503-266-6837 or email credit application to [accounting@obcnw.com](mailto:accounting@obcnw.com). Please allow 7 – 10 business days for application to be processed.

Business Name \_\_\_\_\_ Credit Requested \_\_\_\_\_  
Address \_\_\_\_\_ Federal ID# \_\_\_\_\_  
City \_\_\_\_\_ ST \_\_\_\_\_ Zip \_\_\_\_\_ **Tax Exempt: NO ( ) YES ( ) If so, attach certificate**  
Mailing Address, if different \_\_\_\_\_ Tax Exempt/Resale Cert # \_\_\_\_\_  
Telephone \_\_\_\_\_ Fax \_\_\_\_\_ Website \_\_\_\_\_  
Invoice Preference: ( ) Mail ( ) Email Email address \_\_\_\_\_ Are PO's Required? NO ( ) YES ( )  
Years in Business \_\_\_\_\_ Annual Sales \_\_\_\_\_ ( ) Corporation ( ) Partnership ( ) Proprietor ( ) LLC

Principal \_\_\_\_\_ Phone \_\_\_\_\_ Cell \_\_\_\_\_ Email \_\_\_\_\_  
Buyer(s) \_\_\_\_\_  
Accounts Payable: \_\_\_\_\_ Phone \_\_\_\_\_ Cell \_\_\_\_\_ Billing Email \_\_\_\_\_

Bank Reference: (Name) \_\_\_\_\_ Acct \_\_\_\_\_  
Street Address \_\_\_\_\_ City \_\_\_\_\_ State \_\_\_\_\_ Zip \_\_\_\_\_  
Phone: \_\_\_\_\_ Fax \_\_\_\_\_ Contact Person \_\_\_\_\_ Email \_\_\_\_\_  
Operating Line of Credit NO ( ) YES ( )

### Trade References:

Company _____	Company _____	Company _____
Fax _____	Fax _____	Fax _____
Email _____	Email _____	Email _____
Account # _____	Account # _____	Account # _____

**Terms and Conditions of Sale and Related Financial Terms:** OBC Northwest, Inc.'s (OBC) standard payment terms are net 30 days. These terms may vary with promotions and material being purchased. Cash discounts, if offered, are not allowed past discount "Due Date". **Applicant** hereby certifies that full and timely payment will be made for all purchases. In the event any monies are not paid in full on or before the "Due Date", an interest rate shall accrue on said unpaid balance at the rate of 0.75% per month, or the maximum rate allowed by law, until paid in full. Delinquent accounts past 60 days will be frozen until account is paid in full. The **Applicant** shall be responsible for all expenses including, but not limited to, attorney's fees, court costs and all collection fees. Should it become necessary to file suit to enforce payment, **Applicant** agrees that such suit will be brought in the county of Clackamas, state of Oregon. The Applicant acknowledges that the seller retains the absolute right to limit the amount of credit or refuse further credit to the buyer at any time. OBC gladly accepts credit card payments at time of order. **OBC does NOT accept the use of credit/debit cards for any part of your outstanding account balance.** Returned checks will be charged a \$25 processing fee.

**Policies and Procedures:** All pricing is subject to change without prior notice. A deposit of up to 50% may be required on special/custom orders. We will ship via: will call, OBC Truck, UPS, LTL, and US mail. All shipping, unless otherwise authorized is FOB Canby, Oregon. Shipping and handling fees will be charged at current market value. We will not assume responsibility for damaged, lost or stolen shipments. Please contact the carrier directly to report any freight claims within 24 hours. OBC will not be responsible or be held accountable for the abuse or misuse of any product in which we carry, market, or sell. Authorization is required before returns will be accepted. All products returned must be accompanied with the invoice and returned in its original condition, unless product has not performed within written warranties. Goods must be returned within **30 days** of shipment in order to receive credit. Goods that have been special ordered or that are not a stock item may NOT be returned. Burlap, and other specified items, CANNOT be returned. All returns will be assessed a handling charge of up to 20%, unless otherwise authorized. We reserve the right to refuse orders or service to anyone at anytime.

The **Applicant** represents that they have read and fully understands all of the terms and conditions of sale as listed on this application and are authorized to accept these terms and conditions of sale and all facts contained herein are truthful to the best of their knowledge. An electronic copy of application will be deemed as original. No oral agreements or modifications to this credit application will be accepted.

I/We agree to notify OBC promptly of any changes in ownership of the business conducted under the account name, and agree to liability for all charges to the business conducted under the account name unless and until you receive written notice of a change in ownership of that business.

Signature \_\_\_\_\_ Date \_\_\_\_\_  
Print Name \_\_\_\_\_ Title \_\_\_\_\_





# OBC Greenhouses



- The highest quality galvanized carbon steel pipe is used in the construction of all our greenhouses
- Customized shade cloth to your specifications
- Engineered and non-engineered
- Springlock for attaching polyfilm to greenhouse
- Poly greenhouse film: over-wintering, 1 year or 4 year film
- Exhaust fans, shutters and cool pads
- Single wall & double wall polycarbonate sheeting
- Pots, flats, inserts and potting mixes
- Heaters: natural gas or propane
- Inflation fans and brackets
- Convection tubing
- Liquid shading compound
- Doors
- Benches, rolling and stationary
- Greenhouse controls for heating and cooling

*OBC Northwest Manufactured:*

## **SEMI-GABLE**

*30' & 24' wide*

## **SEMI-QUONSET**

*20' wide*

## **QUONSET**

*30' & 15' wide*

*OBC Northwest also offers:*

## **CONLEY** GUTTER CONNECTED

## **GINTEC** STEEL STRUCTURE

Give us a call at 1-800-477-4744  
for more information.



# EARTHPOTS PALS



JEEZ, I'M REALLY SCARED ABOUT MY TRANSITION FROM POT TO GROUND!

NO NEED TO BE! WE'VE BEEN PLANTED IN EARTHPOTS! JUST LIKE EVERYTHING IN THIS GARDEN!

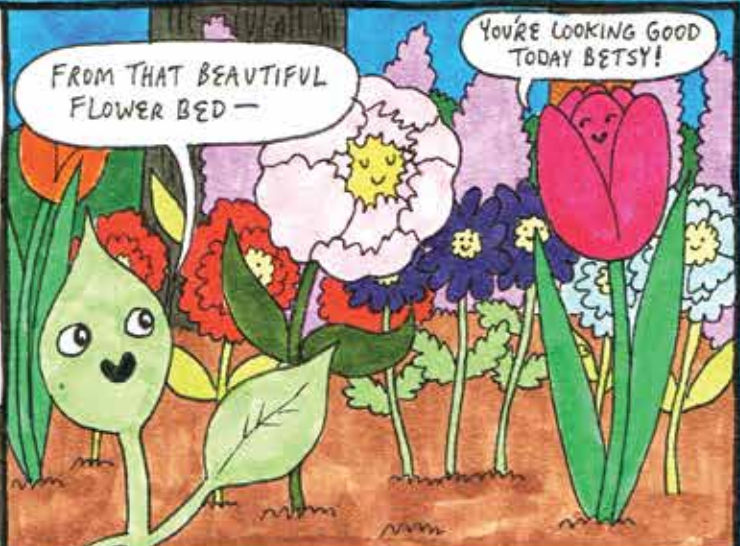

FROM THAT BEAUTIFUL FLOWER BED -

YOU'RE LOOKING GOOD TODAY BETSY!



-TO THAT HEALTHY BLUESBERRY BUSH!

♪ MY ROOTS ARE STRONG! ♪  
♪ DA-NA DA-NA ♪



REALLY? THEY LOOK SO HAPPY AND HAVE SUCH STRONG ROOTS!

THAT'S BECAUSE EARTHPOTS ARE 100% BIO-DEGRADABLE AND ELIMINATE TRANSPLANT SHOCK!



WOW! THAT REALLY WAS NOTHING TO BE AFRAID OF!

AND SOON WE'LL BE TALL HEALTHY TREES THANKS TO EARTHPOTS GIVING VS STRONG ROOTS!

**OBC NORTHWEST, INC.**  
NURSERY & GREENHOUSE SUPPLIES

**EARTHPOTS®**  
LIVE HEALTHY · PLANT HEALTHY  
Manufactured by  
OBC Northwest Inc. Canby, OR

1076 SW Berg Parkway, Canby, Oregon 97013

Printed in U.S.A. 800-477-4744 • 503-266-6837 (fax) • Email: [obc@obcnw.com](mailto:obc@obcnw.com) • [www.obcnw.com](http://www.obcnw.com)